

Hybrid Modelling and Control of the Common Rail Injection System

Andrea Balluchi^{1,2}, Antonio Bicchi², Emanuele Mazzi^{1,2},
Alberto L. Sangiovanni Vincentelli^{1,3}, and Gabriele Serra⁴

¹ PARADES, Via S. Pantaleo, 66, 00186 Roma, Italy
{balluchi, emazzi, alberto}@parades.rm.cnr.it

² Centro Interdipartimentale di Ricerca “Enrico Piaggio”,
Università di Pisa, 56100 Pisa, Italy

bicchi@ing.unipi.it

³ Dept. of EECS., University of California at Berkeley, CA 94720, USA
alberto@eecs.berkeley.edu

⁴ Magneti Marelli Powertrain, Via del Timavo 33, 40134 Bologna, Italy
Gabriele.Serra@bologna.marelli.it

Abstract. We present an industrial case study in automotive control of significant complexity: the new common rail fuel injection system for Diesel engines, currently under production by Magneti Marelli Powertrain. In this system, a flow-rate valve, introduced before the High Pressure (HP) pump, regulates the fuel flow that supplies the common rail according to the engine operating point. The standard approach followed in automotive control is to use a mean-value model for the plant and to develop a controller based on this model. In this particular case, this approach does not provide a satisfactory solution as the discrete-continuous interactions in the fuel injection system, due to the slow time-varying frequency of the HP pump cycles and the fast sampling frequency of sensing and actuation, play a fundamental role. We present a design approach based on a hybrid model of the Magneti Marelli Powertrain common-rail fuel-injection system for four-cylinder multi-jet engines and a hybrid approach to the design of a rail pressure controller. The hybrid controller is compared with a classical mean-value based approach to automotive control design whereby the quality of the hybrid solution is demonstrated.

1 Introduction

Common-rail fuel-injection is the dominant system in diesel engine control. In common-rail fuel-injection systems (see Figure 1), a low-pressure pump located in the tank supplies an HP pump with a fuel flow at the pressure of 4–6 bars. The HP pump delivers the fuel at high pressure (from 150 to 1600 bars) to the common rail, which supplies all the injectors. The fuel pressure in the common rail depends on the balance between the inlet fuel flow from the HP pump and the outlet fuel flow to the injectors. The common-rail pressure is controlled to achieve tracking of a reference signal that is generated on-line (it depends on the engine operating point) to optimize fuel injection and to obtain proper combustion with low emissions and noise.

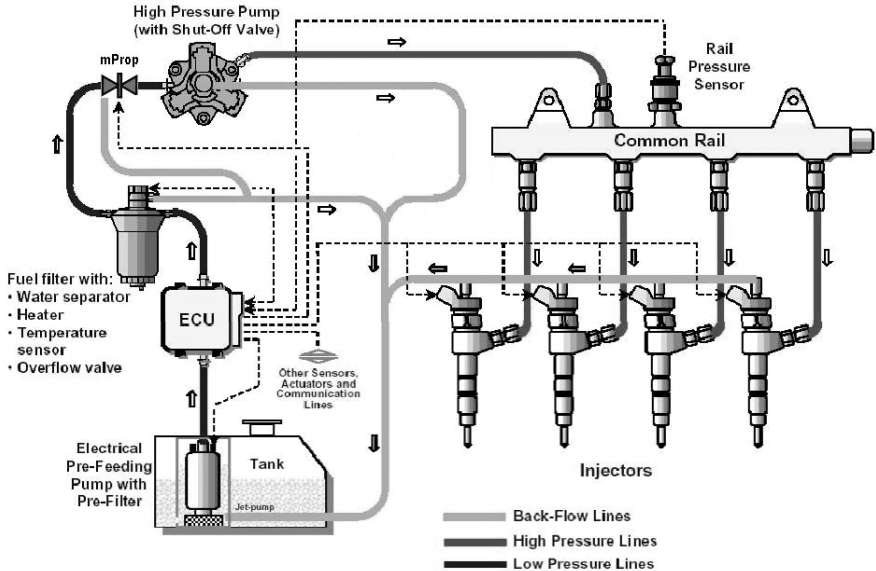

Fig. 1. Common rail fuel injection system developed by Magneti Marelli Powertrain

In the novel fuel-injection system developed by Magneti Marelli Powertrain, a flow-rate valve located before the HP pump allows for effective control of the amount of fuel that is compressed to high pressure and delivered to the rail. The HP pump and, hence, the rail are supplied with the precise amount of fuel flow that is necessary for fuel injection, achieving high efficiency of the injection system. The previous fuel injection system, which was not equipped with the flow-rate valve, was characterized by a high power consumption by the HP pump, which always supplied with the maximum fuel flow for the current operating condition (rail pressure control was achieved by a regulation valve located on the rail).

To control the rail pressure efficiently, we need to model accurately the interaction between discrete and continuous behaviours of the injection system components, exhibiting the pulsating evolution of the rail pressure due the discontinuous inlet fuel flow from the HP pump and outlet fuel flows to the injectors. To do so, we present in this paper a hybrid model of the Magneti Marelli Powertrain common-rail fuel-injection system for four-cylinder multi-jet engines. Motivated by the success in solving other automotive control problems using hybrid system methodologies, e.g. cut-off control [1], intake throttle valve control [2], actual engaged gear identification [3], and adaptive cruise control [4], we developed a hybrid rail pressure controller that exhibits excellent performance. To compare our solution with the standard design methodology adopted in the automotive industry based on mean-value models of the plant, we present a classical Smith Predictor discrete-time controller. Simulations of the closed-loop system show that the mean-value model design approach does not achieve the same quality of design as the hybrid approach.

We believe this paper underlines the important role played by hybrid systems in solving complex industrial control problems in a domain as economically relevant as the automotive sector.

2 Hybrid Model of the Common Rail Injection System

The proposed hybrid model of the injection system, shown in Figure 2, consists of: the flow-rate valve, the HP pump, the injectors and the common rail [5]. The proposed hybrid model describes accurately the interacting discrete and continuous behaviours of the injection system components, reproducing the pulsating evolution of the rail pressure due the discontinuous inlet fuel flow from the HP pump and outlet fuel flows to the injectors. The rail pressure p [bar] is the controlled output. The flow-rate valve duty cycle $u \in [0, 1]$ is the control input. The injectors fuel flow q^{INJ} [mm³/sec], which depends on the injectors opening times ET [sec], is considered as a disturbance to be compensated. The models of the components of the system are described in the next sections using the hybrid automaton formalism [6].

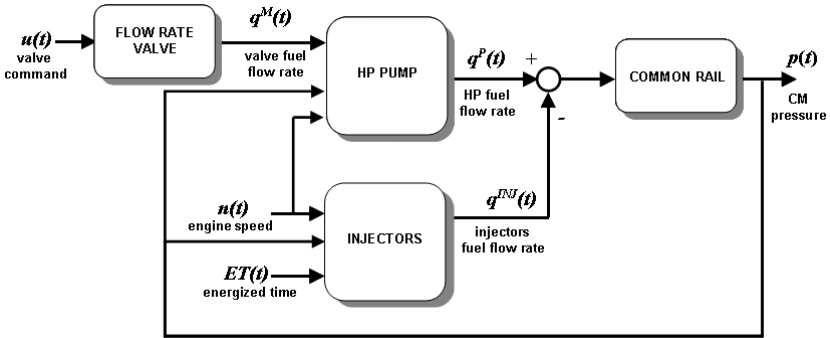

Fig. 2. Hybrid model of the fuel injection system

2.1 The Flow-Rate Valve

The hybrid model of the flow-rate valve is depicted in Figure 3 and includes: the valve PWM¹ electrical driver; the dynamics of the coil current I [A]; and the relation between the coil current and the fuel flow-rate q^M [mm³/sec] across the valve.

The PWM electrical driver model is a hybrid model with as output a square wave voltage $v^{PWM}(t) \in \{0, V_{bat}\}$ given by pulse-width modulation of the battery voltage V_{bat} with duty cycle defined by the control input signal $u(t) \in [0, 1]$. Its implementation is based on a triangular wave generator with period T_0 and

¹ Pulse Width Modulation.

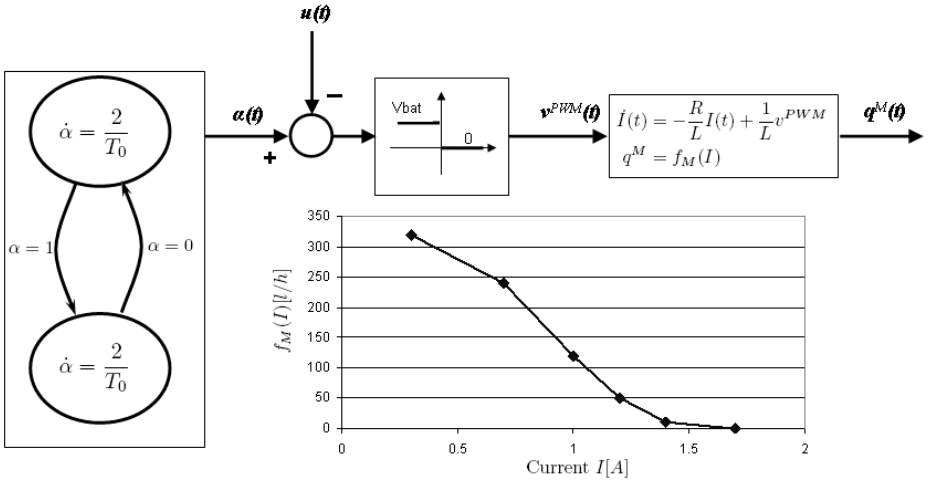

Fig. 3. Flow-rate valve hybrid model

output $\alpha(t)$, modelled as a hybrid system. The dynamics of the coil current I depends on the coil resistance R and inductance L . The relation between the coil current I and the fuel flow rate q^M is given by a nonlinear function

$$q^M = f_M(I) \tag{1}$$

represented as a piecewise affine expression (see [7]).

2.2 The HP Pump

The HP pump consists of three identical hydraulic rams mounted on the same shaft with a relative phase of 120° (see Figure 4). Since the pump is powered by

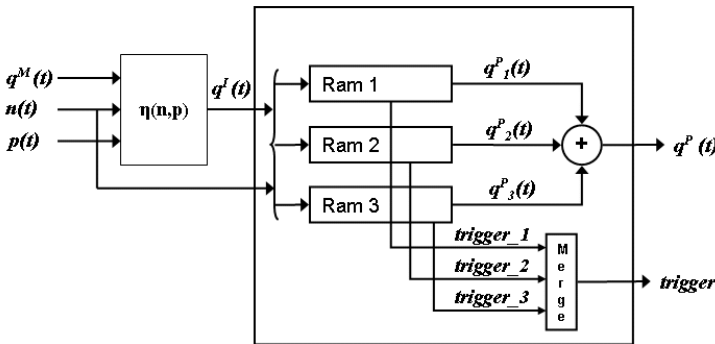

Fig. 4. HP pump hybrid model

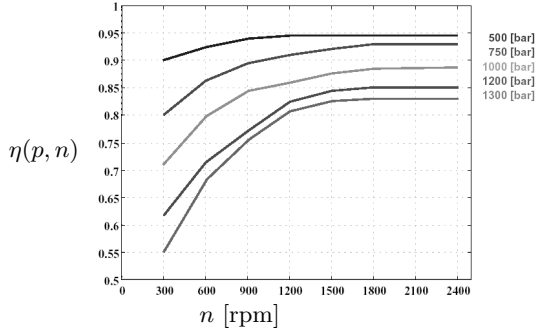

Fig. 5. HP pump efficiency

the camshaft, its revolution speed depends on the engine speed n [rpm]. Pump efficiency reduces the fuel flow q^I [mm³/sec] to the rams, i.e.

$$q^I = \eta(p, n)q^M \quad (2)$$

where the efficiency $\eta(p, n)$ depends on the rail pressure and the engine speed as depicted in Figure 5. The HP pump fuel flow to the rail q^P [mm³/sec] is obtained by adding the contributions q_i^P of the three rams: $q^P = q_1^P + q_2^P + q_3^P$.

The partial closure of the flow-rate regulation valve produces the cavitation phenomenon in the pump, which affects both the intake and compression phases. For small effective area of the flow-rate valve, the pressure reduction in the ram during the intake phase causes fuel vaporization [8]. As a consequence, the amount of fuel charge in volume is lower than the geometric displacement of the cylinder. The partial fuel charge depends on the amount of fuel vapor in the cylinder. In a first part of the compression phase, the ram does not deliver any fuel to the rail. In fact, at the beginning of the compression phase, the increase of pressure inside the cylinder causes fuel condensation only. The outlet flow to the rail starts when the fuel is completely in the liquid state, i.e. when the geometric volume of the cylinder (which decreases during compression) equals the fuel charge in volume. From this time on, pressure increase in the ram produces the opening of outlet valve and the exit of the compressed fuel to the rail.

The hybrid model of the i -th ram of the HP pump is depicted in Figure 6. Its evolution is determined by the ram angle ϕ_i [°]. Since the camshaft revolution speed is half the engine speed n , then the ram angle dynamics is $\dot{\phi}_i = \frac{360}{2} \frac{n}{60} = 3n$, where n is the engine speed in rpm.

The hybrid model contains two macro discrete states corresponding to the intake and compress phases, which have durations of half camshaft cycle. The pumping cycle starts with the beginning of the intake phase, which is triggered by the guard $\phi_i = 180^\circ$. The camshaft sensor detects the beginning of the pumping cycle by emitting the output event $trigger_i$ at transition time.

Since the intake duration is 180° and the three rams are mounted with a relative phase of 120° , then the intake phases of the rams partially overlap. Intake overlapping results in different supplying fuel flow to the rams. Rams

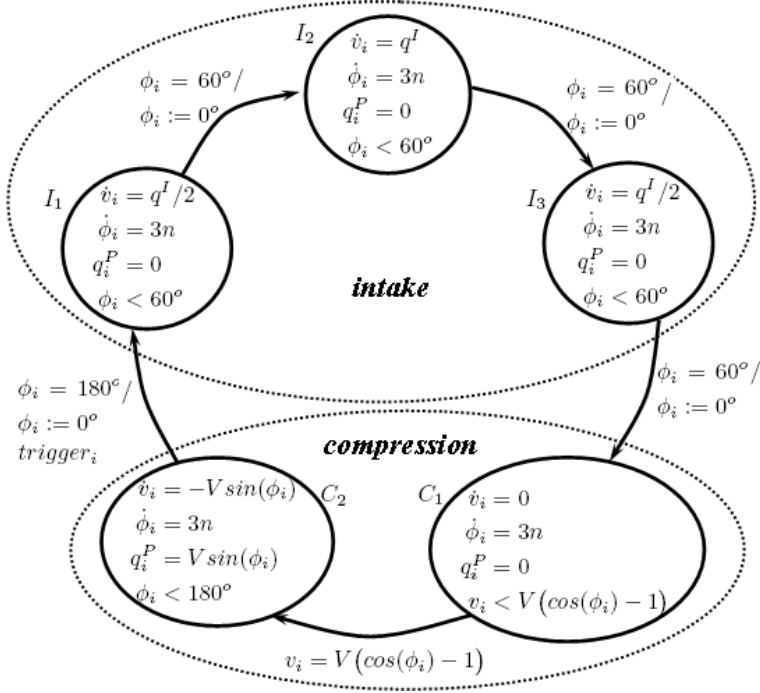

Fig. 6. Hybrid model of the i -th ram of the HP pump

overlapping is modelled in the i -th ram hybrid model by including three discrete states I_1 , I_2 and I_3 inside the **intake** state. In each state the model dwells for a duration of 60° of the ram angle ϕ_i . Concurrent intake with one of the other rams occurs in the first and the last part of the intake, i.e. in I_1 and I_3 . Assuming that, in case of concurrent intake, both rams receive half of the flow q^I given by (2), then the amount of fuel v_i [mm³] inside the i -th ram is subject to the dynamics: $\dot{v}_i = q^I/2$ in I_1 and I_3 ; and $\dot{v}_i = q^I$ in I_2 .

The **compression** state consists of two different states: C_1 , modeling fuel condensation, and C_2 , modeling fuel delivery to the rail. On entering the **compression** state, the ram angle ϕ_i is reset. During fuel condensation in state C_1 , the fuel charge in the ram remains constant ($\dot{v}_i = 0$) and the fuel flow-rate to the rail q_i^P is zero. The system remains in state C_1 while the geometric volume of the ram $V(\cos(\phi_i) - 1)$ is greater than the fuel charge v_i . When all fuel is at the liquid state (i.e. $v_i = V(\cos(\phi_i) - 1)$), the model switches to state C_2 where: the outlet valve is open, the compressed fuel flows towards the rail with flow-rate $q_i^P = V \sin(\phi_i)$, and the ram fuel charge decreases as $\dot{v}_i = -V \sin(\phi_i)$. The **compression** state is left when the ram angle ϕ_i reaches 180° .

2.3 Injectors

The common rail supplies four injectors, one for each cylinder of the engine. In multi-jet engines, each injection phase is composed by a sequence of 3 to 5

distinct injections. However, in most of the engine operating conditions only three injections are used. For the sake of simplicity, we consider this case. The three injections are: a pilot injection (applied to reduce combustion time by increasing cylinder temperature and pressure), a pre-injection (used to reduce production of emissions by optimizing combustion conditions) and a main injection (which produces the desired engine torque). Having the engine four cylinders, the frequency of injection sequences is twice the engine speed. The engine torque controller implemented in the engine control unit defines the amount of fuel to be injected and, consequently, the durations $ET = (\tau^{PIL}, \tau^{PRE}, \tau^{MAIN})$ [sec] and phases $(\theta^{PIL}, \theta^{PRE}, \theta^{MAIN})$ (expressed in crank angle) of each fuel injection, depending on the engine operating condition.

The amount of fuel that flows from the common rail to each injector is the sum of three different terms: the flow that enters the combustion chamber Q_{inj} , a flow necessary to keep the injector open Q_{serv} , and a leakage flow Q_{leak} . The latter two are collected into the tank. While the leakage flow-rate Q_{leak} is a continuous signal, the flow-rate Q_{inj} and Q_{serv} are not zero only when the injector is open. Since the common rail model is zero-dimensional and in each engine stroke only an injector is operated, then there is no loss of generality in referring the quantities Q_{inj} , Q_{serv} , Q_{leak} to the overall contribution of the four injectors to the common rail balance, with injection frequency twice the engine speed.

The fuel flow-rate q^{INJ} [mm³/sec] out of the common rail is represented by the hybrid model reported in Figure 7, where q^L denotes the leakage flow Q_{leak} and q^J stands for the sum of the Q_{inj} and Q_{serv} flows.

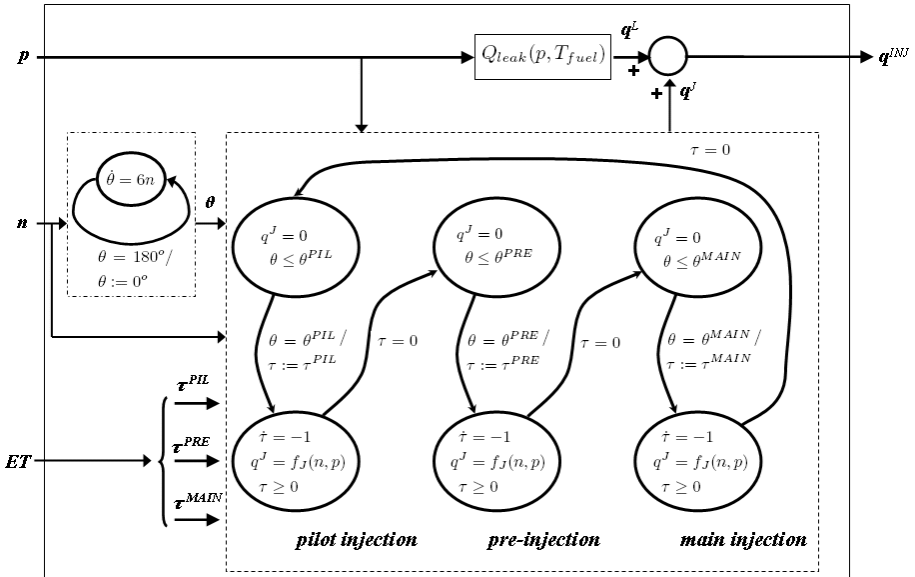

Fig. 7. Hybrid model of the injectors

The three states on the top of the model represent the synchronization phases for the opening of the injectors, which are defined in terms of guards on the crankshaft angle θ [°] that evolves from 0 to 180° with dynamics $\dot{\theta} = 6n$. Parameters θ^{PIL} , θ^{PRE} , θ^{MAIN} denote the corresponding start of injection angles. In these states, the fuel flow to the injectors is due to leakage only, i.e. $q^J = 0$.

As soon as the guard conditions $\theta = \theta^{PIL}$, $\theta = \theta^{PRE}$, $\theta = \theta^{MAIN}$ become true, a transition to the corresponding state on the bottom takes place, and the timer τ is initialized to the current injection duration time τ^{PIL} , τ^{PRE} , τ^{MAIN} . The three states on the bottom model the system with one injector open. The flow to the open injector depends on the engine speed and the rail pressure: $q^J = f_J(n, p) = Q_{inj}(p, n) + Q_{serv}(p, n)$. The system remains in the injection states until the injection time elapses, i.e. $\tau = 0$.

2.4 Common Rail

The dynamics of the rail pressure is obtained by considering the balance between the HP pump inlet flow and injectors outlet flows. Under the assumption of not deformable rail, the fuel volume is constant, while the capacity depends on the pressure and temperature of the fuel in the rail according the Bulk module, which takes into account fuel compressibility. The evolution of the rail pressure is given by:

$$\dot{p}(t) = \frac{K_{Bulk}}{V_{rail}} (q^P(t) - q^{INJ}(t)), \tag{3}$$

where the HP pump fuel flow q^P is given by the hybrid model in Figure 4 and the injector fuel flow q^{INJ} is given by the hybrid model in Figure 7.

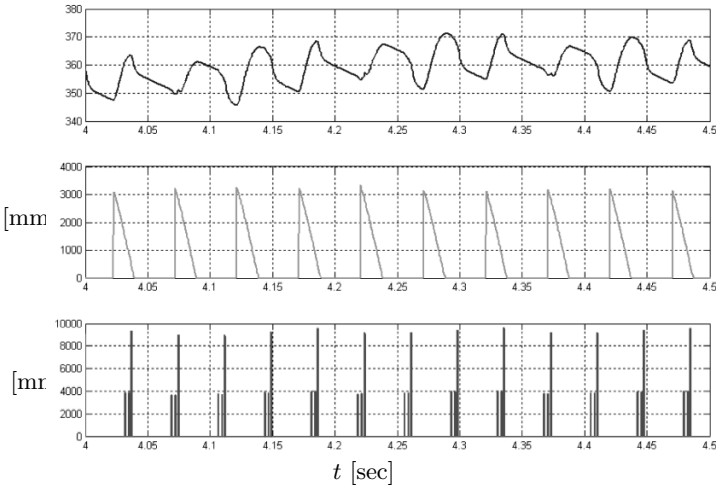

Fig. 8. Rail pressure pulsating profile and HP pump and injectors fuel flows

Simulation results obtained with the proposed common rail hybrid model show that it nicely represents the pulsating behaviour of the common rail pressure due to the HP pump and injectors discontinuous evolutions. Figure 8 reports a typical evolution of the common rail pressure, along with the pulsating fuel flows of the HP pump and the injectors. When the pump delivers the fuel, the pressure increases while when the injectors open, the pressure decreases.

3 Control Design

The objective is to design a feedback controller for the rail pressure that achieves tracking of a reference pressure signal. The latter is generated on-line by an outer loop control algorithm so to optimize fuel injection and obtain proper fuel combustion, with low emissions and noise, for the current engine operating point. The specifications for the rail pressure controller are:

- steady state rail pressure error lower than 30 bar;
- settling time lower than 150 mseconds;
- undershoot/overshoot lower than 50 bar, for a ramp of rail pressure reference with rate 800 bar/sec, at 1000 rpm, with 15 mm³/stroke fuel injection.

The most important aspect to be taken into account in the design of the control algorithm is the varying time delay between the flow–rate valve control command u and the pulsating fuel flow from the HP pump to the rail. This delay is due to HP pump cycles and is roughly in inverse proportion to engine speed. As a consequence, the control task is particularly critical during cranking and at low engine speed.

3.1 Controller Based on the Smith Predictor

In this section, we develop a “standard” controller based on a mean–value model of the plant. To cope with the large and time–varying loop delay, the controller is based on the Smith Predictor. The rail pressure Smith Predictor controller (see e.g. [9, 10]) is obtained following the standard approach to controller design adopted in the automotive industry that is based on mean–value modelling of the plant. The following continuous time model is considered:

$$\dot{I}(t) = -\frac{R}{L}I(t) + \frac{v^{PWM}(t)}{L} \quad (4)$$

$$\dot{p}(t) = \frac{K_{bulk}(p)}{V_{rail}} \left[(q^P(t - \hat{T}_d) - q^{INJ}(t)) \right] \quad (5)$$

where $\hat{T}_d = 120/n$ is an estimate of the loop delay. The controller includes a model of the high pressure circuit and a PID with anti–windup and feedforward terms. The control algorithm is implemented in discrete time, with a sampling time of 5 mseconds. Satisfactory rail pressure tracking is achieved provided that the rate of variation of the reference pressure is not too large. Figure 9 reports a typical rail pressure evolution.

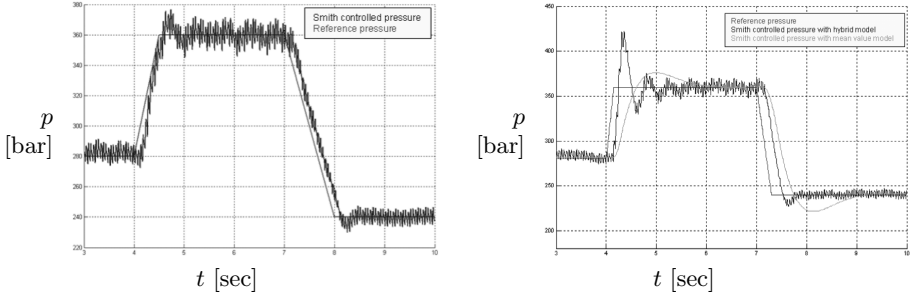

Fig. 9. Closed-loop hybrid system simulation results with the Smith Predictor: for slow (left) and fast (right) pressure references

However, the tracking performance significantly degrades and large overshoots are produced for fast rail pressure reference signals, as described in Figure 9. On the other hand, the simulation of the Smith Predictor controller against the mean-value model exhibits the expected behaviour showing that the controller is able to compensate properly the time delay. Hence, the poor tracking performances shown in the simulations with the common rail hybrid model demonstrate that mean-value modelling is not accurate enough to design high quality control. In fact, major difficulties in the calibration of mean-value model-based controllers for fast reference pressure signals were observed by Magneti Marelli Powertrain. From the closed-loop hybrid model simulation shown in Figure 9, to be able to efficiently track fast pressure references, the controller should be designed taking into account each single fuel delivery of the HP pump. In fact, in the reported simulation, only three compression phases of the HP pump drive the pressure close to the target value. From a physical point of view, the HP pump combines a sequence of control actions to determine the fuel charge for each single cycle. However, this behaviour is not taken into account by the pressure controller designed on the basis of the mean-value model of the system, which then exhibits large overshoot.

This analysis motivates the search for a better solution that can be offered by designing a hybrid controller that is based on the accurate hybrid model presented above.

3.2 Hybrid Multi-rate Controller

During the intake phases, the HP pump combines a sequence of control actions to determine the fuel charge for each single cycle. Hence, the HP pump introduces an under-sampling of the control actions. The slow frequency of intake and delivery of the HP pump is time varying since it depends on the engine speed. A hybrid system approach to controller design allows us to effectively handle the under-sampling produced by the HP pump cycles and properly handle the drift between the fast frequency of sensing and actuation (at 5 mseconds) and frequency of the HP pump [11].

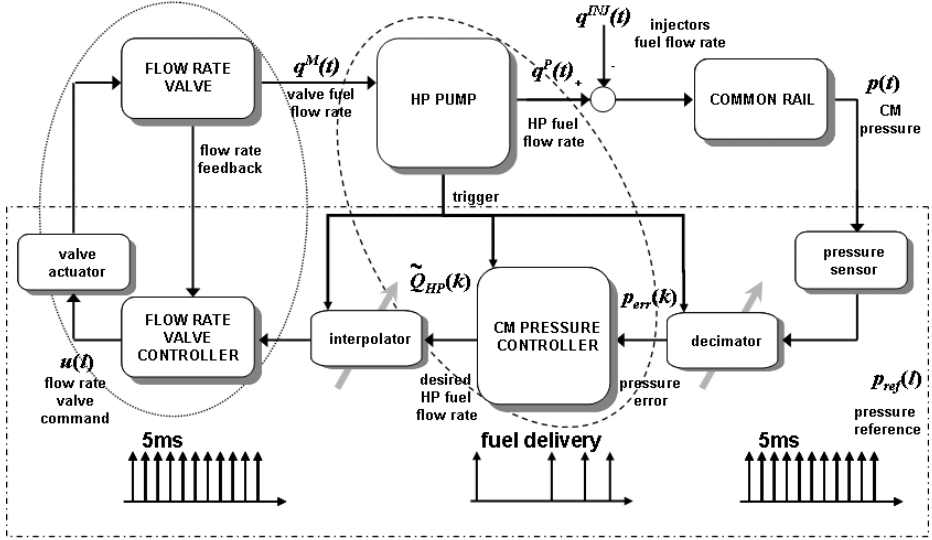

Fig. 10. Hybrid multi-rate controller

The proposed hybrid multi-rate controller, showed in Figure 10, consists on two regulators:

- The *CM pressure controller* is event-based and is synchronous with the HP pump fuel intake phases (it receives the HP pump *trigger* event from the camshaft sensor). This controller defines the desired fuel mass $\tilde{Q}_{HP}(k)$ [mm³/stroke] needed to control the rail pressure error $p_{err}(k)$ to zero. A PI control with anti-windup and feedforward terms is used for this purpose.
- The *flow-rate valve controller* runs at 5 mseconds. Its task is to feed the high pressure circuit with the amount of fuel $\tilde{Q}_{HP}(l)$ requested by the outer loop controller. Due to the lack of a fuel flow-rate sensor downstream the valve, the flow-rate valve controller has to be open-loop. The duty cycle control u is obtained by abstracting away the coil current dynamics and inverting the flow-rate valve characteristic (1) and the PWM model, i.e.

$$u = \frac{2}{3} \frac{R}{V_{batt}} f_M^{-1}(\tilde{Q}_{HP}(l)). \quad (6)$$

The factor $\frac{2}{3}$ is introduced to take into account the partial overlapping of the intakes phases of the rams in HP pump.

Smooth and effective coupling between the different time domains of pressure sensing, CM pressure control and flow-rate valve control is achieved by using a decimator and an interpolator [12].

- The decimator converts the high frequency pressure error $p_{err}(l) = p(l) - p_{ref}(l)$, having sampling time 5 mseconds, to the time-varying HP pump frequency. An IIR low-pass filter is employed (see Figure 11).

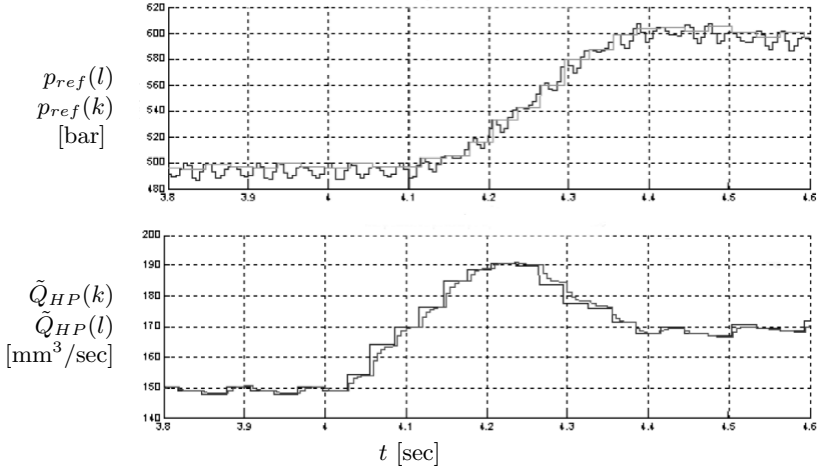

Fig. 11. Signal conversions provided by the decimator and the interpolator

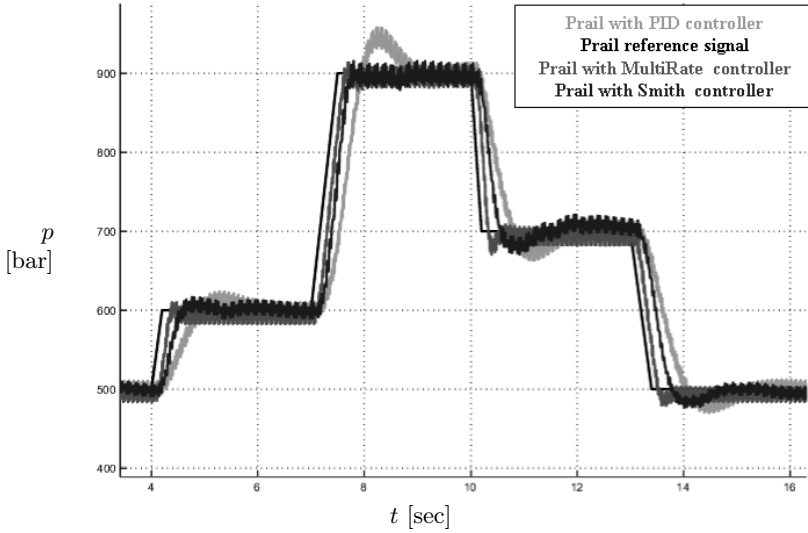

Fig. 12. Comparison between the proposed hybrid multi-rate controller and a controller based on the Smith Predictor developed using a mean-value model of the plant

- The interpolator converts the fuel mass signal $\tilde{Q}_{HP}(k)$ in $[\text{mm}^3/\text{stroke}]$, synchronous with the time-varying HP pump frequency to the 5 msecond discrete-time domain, $\tilde{Q}_{HP}(l)$ in $[\text{mm}^3/\text{sec}]$ used by the flow-rate valve controller. An IIR low-pass filter is employed in the interpolator. The interpolator produces a smooth and uniform input signal to the flow-rate valve controller as illustrated in Figure 11.

Both the decimator and the interpolator implement a gain scheduling of the cut-off frequency based on engine speed to compensate the variation of the HP pump frequency.

The simulation results presented in Figure 12 show the improvement obtained by the proposed hybrid multi-rate controller with respect to a controller based on the Smith Predictor presented in the previous section. Both controllers have been tuned to meet the specification on bounded overshoot. The settling time of the hybrid multi-rate controller is significantly shorter than the one of the Smith Predictor controller. Moreover, the hybrid multi-rate regulator, which implements a PI algorithm and two low-pass filters, is significantly simpler than the Smith Predictor that includes an internal model of the plant. Finally, while the Smith Predictor is affected by a time delay estimation error, in the multi-rate controller the loop delay is simply represented by a one step delay. Simulation results show that the hybrid multi-rate controller is robust to phase errors between the CM pressure controller execution and the beginning of intake phases of the rams.

4 Conclusions

We presented a relevant problem in diesel engine control that has been solved with a hybrid system approach. We first developed a hybrid model that takes into account the interactions between the discrete dynamics of the components of the common rail system.

Then we demonstrated the superiority of a hybrid multi-rate control algorithm versus the standard mean-value model approach to controller design adopted in the automotive industry. To do so, we designed a Smith Predictor controller to compensate the loop delay. Simulation results show that such controller achieves satisfactory tracking only for slow rail pressure reference signals. Figure 12 illustrates the improvement achieved by using the multi-rate controller.

In summary, we demonstrated how the use of hybrid models and control algorithms can produce superior results versus standard control approaches based on mean-value models for a relevant and complex industrial problem.

References

1. Balluchi, A., Benedetto, M.D.D., Pinello, C., Rossi, C., Sangiovanni-Vincentelli, A.L.: Hybrid control in automotive applications: the cut-off control. *Automatica: a Journal of IFAC* **35** (1999) 519–535
2. Baotic, M., Vasak, M., Morari, M., Peric, N.: Hybrid theory based optimal control of electronic throttle. In: *In Proc. of the IEEE American Control Conference, Denver, Colorado, USA, ACC (2003)* 5209–5214
3. Balluchi, A., Benvenuti, L., Lemma, C., Sangiovanni-Vincentelli, A.L., Serra, G.: Actual engaged gear identification: a hybrid observer approach. In: *16th IFAC World Congress, Prague, CZ, IFAC (2005)*

4. Mobus, R., Baotic, M., Morari, M.: Multi-object adaptive cruise control. *Hybrid Systems: Computation and Control* **2623** (2003) 359–374
5. Millo, F.: Il sistema common rail. Technical report, Dipartimento di Energetica, Politecnico di Torino (2002)
6. Henzingerz, T.A.: The theory of hybrid automata. Technical report, Electrical Engineering and Computer Sciences University of California, (Berkeley)
7. Bosch: Injection Systems for Diesel Engines. Technical Customer Documents. (2003)
8. Knapp, R.: Cavitation. McGraw-Hill (1970)
9. Rath, G.: Smith’s method for dead time control. Technical report (2000)
10. Mirkin, L.: Control of dead-time systems, K.U.Leuven - Belgium, *Mathematical Theory of Networks and Systems* (2004)
11. Glasson, D.: Development and applications of multirate digital control. *IEEE Control Systems Magazine* **3** (1983) 2–8
12. Vaidyanathan, P.: Multirate digital filters, filter banks, polyphase networks and applications: a tutorial. *Proceedings of the IEEE* **78** (1990) 56–92