



CENTRO E. PIAGGIO

Bioengineering and Robotics Research Center

# LIGA Process

---

G. Vozzi

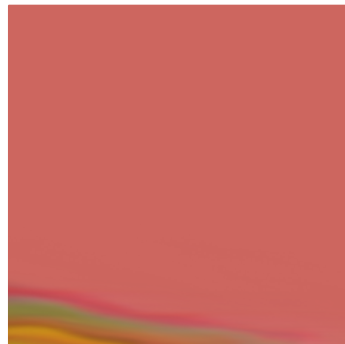
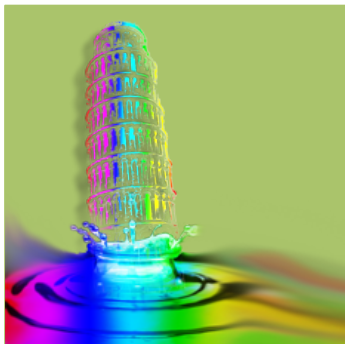
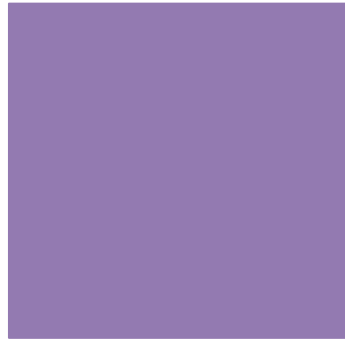

# + LIGA process

The LIGA technique (German acronym for Lithographie, Galvanoformung, Abformung) is based on X-ray lithography.

It combines electrodeposition with X-ray lithography and was first produced by Romankiw at IBM in 1975. They made metal structures with a high aspect ratio. In practice they deposited gold on microfabricated photoresist structures with 20 micrometer high X-ray radiation. In reality this first trial was the LIG. The abformung is the creation of the mold (molding)

The complete development of the LIGA process is due to Ehrfeld at the Karlsruhe Nuclear Research Center in 1982.

This method allows the creation of metal micro-panels with high precision.

# LIGA process

## 1. Irradiation

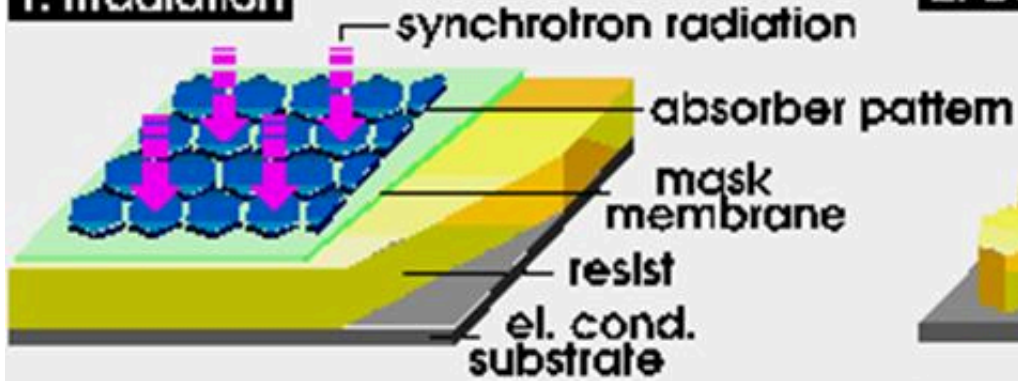

## 2. Development

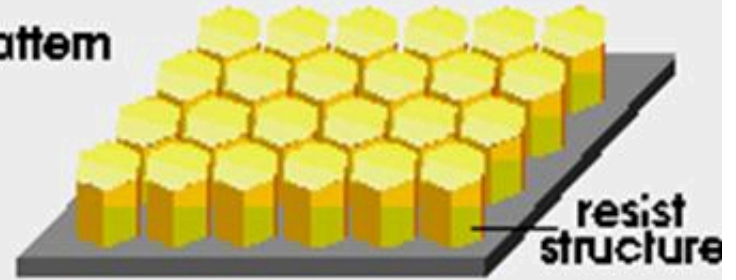

## 3. Electroforming

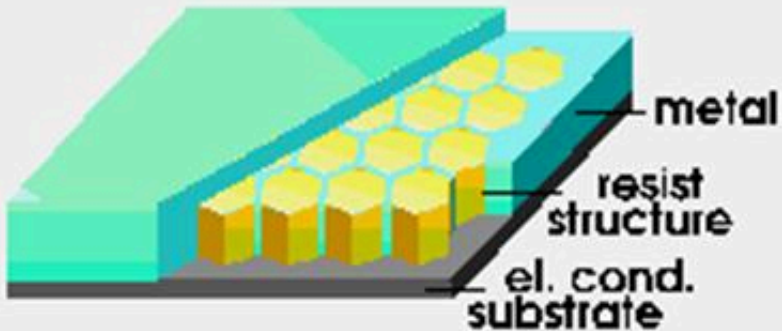

## 4. Mould insert



## 5. Mould filling

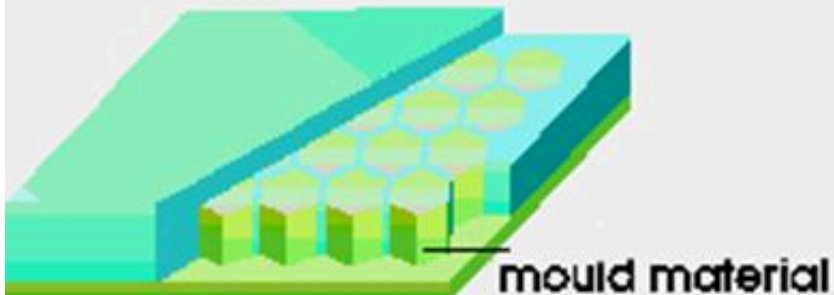

## 6. Mould separation



# Synchronous radiation

Lithography based on synchronous radiation combines the impact of electrons and plasma sources to produce X-rays.

Synchrotron radiation or synchrotron light is an electromagnetic radiation generated by charged particles, usually electrons or positrons, that travel at speeds close to the speed of light and are forced by a magnetic field to move along a curved path. The higher the particle speed, the lower the wavelength of the emitted radiation and generally the peak of the emission occurs at the X-ray lengths. The cost of a synchronous is now about 30 million dollars, but in different countries are developing smaller and at a lower cost.

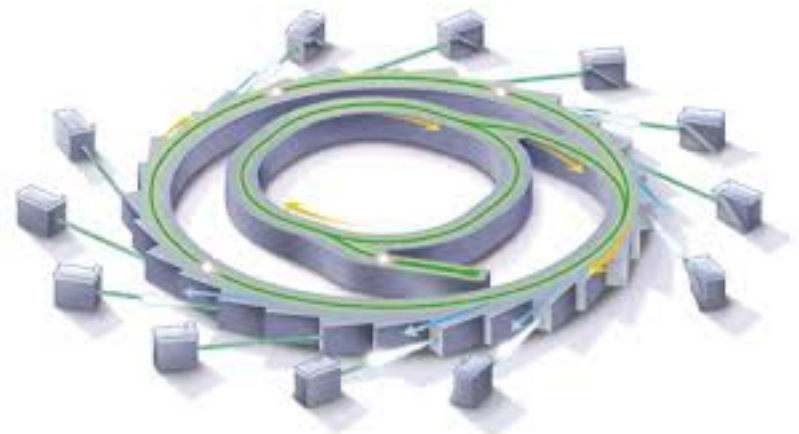
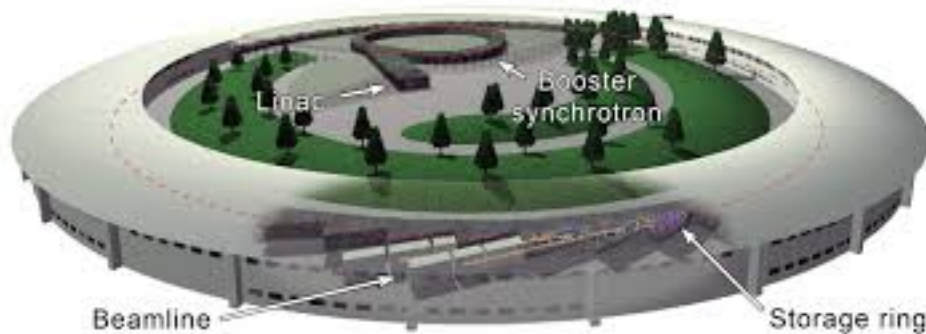

# Synchronous radiation

This system makes it possible to have a higher energy flow than collateral X-rays and therefore allows to reduce exposure times and make large-scale production.

Pro	Contra
It is insensitive to resist thickness, exposure time and development time	The resist used are not very sensitive
Absence of backscattering and insensitivity to the type of substrate used, to reflectivity, topography, dust and contaminants	Masks are difficult to make and are expensive
Resolution of less than 0.2 micrometers	It requires a strong economic investment
Large-scale production	System maintenance costs
	It can have negative effects on silicon oxide

# LIGA

## Mask Production

The production of masks for LIGA is one of the most critical aspects of the process, because they must be transparent to radiation, so it must be made of a thin layer with a low atomic number. It must be reusable, easily aligned with the master and rigid.

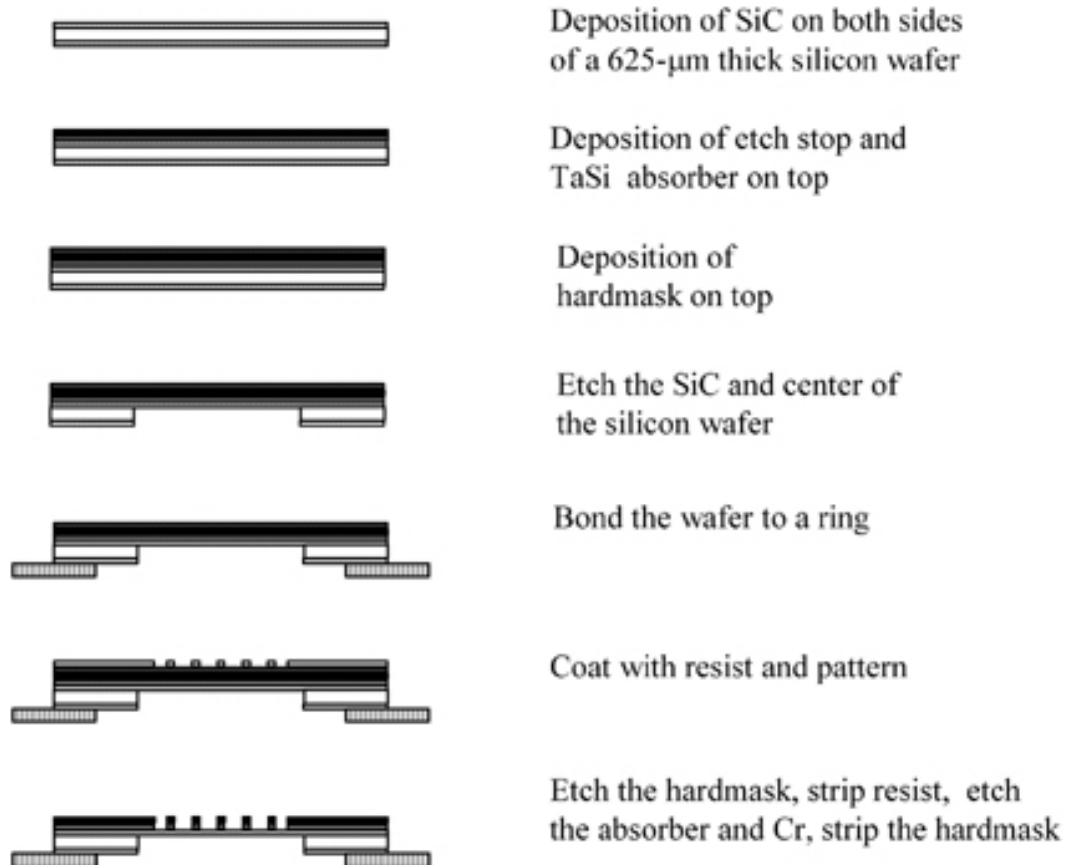

# LIGA

## Mask Production

	lithography	LIGA
Trasparency	$\geq 50\%$	$>80\%$
Thickness of absorbent material	$\pm 1\mu\text{m}$	$10\mu\text{m}$ o di più
Working area	$50 \times 50\text{ mm}^2$	$100 \times 100\text{ mm}^2$
Resistance to the radiation	1	100
Surface rugosity	$< 0.1\mu\text{m}$	$< 0.5\mu\text{m}$
stability	$< 0.05\mu\text{m}$	$< 0.1-0.3\mu\text{m}$
Residual stress in the membrane	$10^8\text{ Pa}$	$10^8\text{ Pa}$

In genere come materiale assorbente si usa l'oro

# LIGA

## Mask Production

During the exposure process the masks are subjected to an exposure of  $1 \text{ MJ} / \text{cm}^2$ . This high energy can distort the membranes and induce thermal stresses inside them, so the materials used are mainly Si, SiNx, SiC, Diamante, BN, Be, Ti.

The titanium and beryllium masks are used specifically for X-rays: to have a good exposure of the PMMA resist of 500 micrometres are covered by a layer of beryllium or titanium of 2 micrometers.

Beryllium has an elastic modulus greater than that of titanium and since the product of the elastic modulus for the thickness of metallic material is inversely proportional to the distortion of the mask, beryllium induces less distortion.

Beryllium masks can be used for 10,000 exposures with a cost that varies between 20,000 and 30,000 dollars per mask.

Silicon nitride has numerous oxygen impurities which undergo x-rays locally heat the mask and therefore alter the resist polymerization process.



# LIGA

## Absorbent materials

Absorbent materials must have high attenuation, be stable under radiation for a long time, easy to pattern, with low density of defects. Typical absorbent materials are gold, tungsten, tantalum and their alloys.

In general, the X-ray mask is composed of a first layer of preabsorbent in general Katpon, deposited on a titanium or beryllium membrane, below it is deposited a layer of gold and then this is in direct contact with the resist.

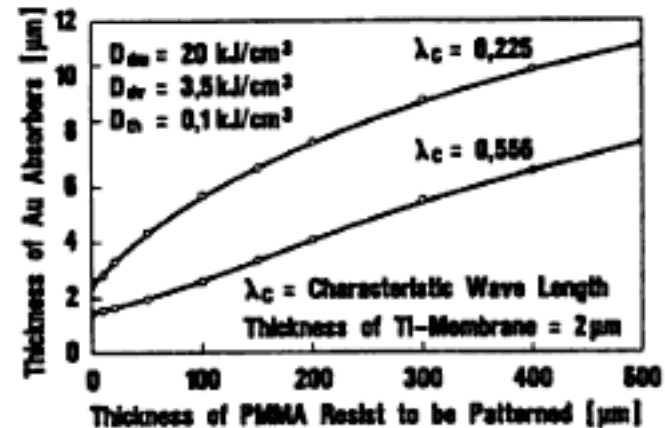
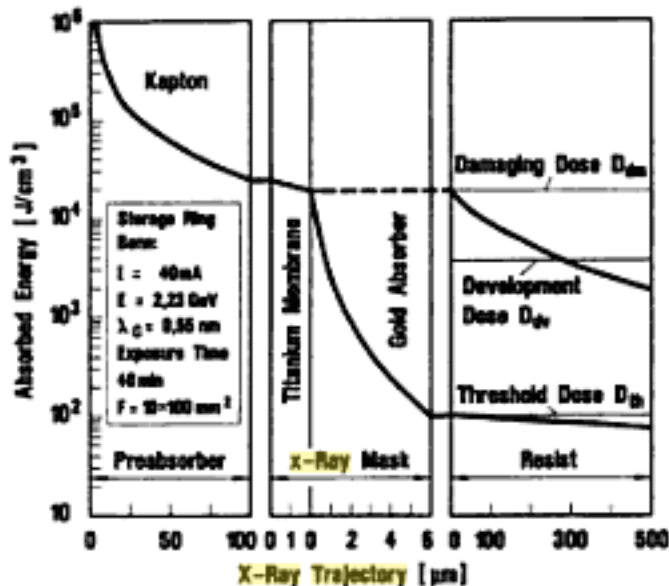

# LIGA

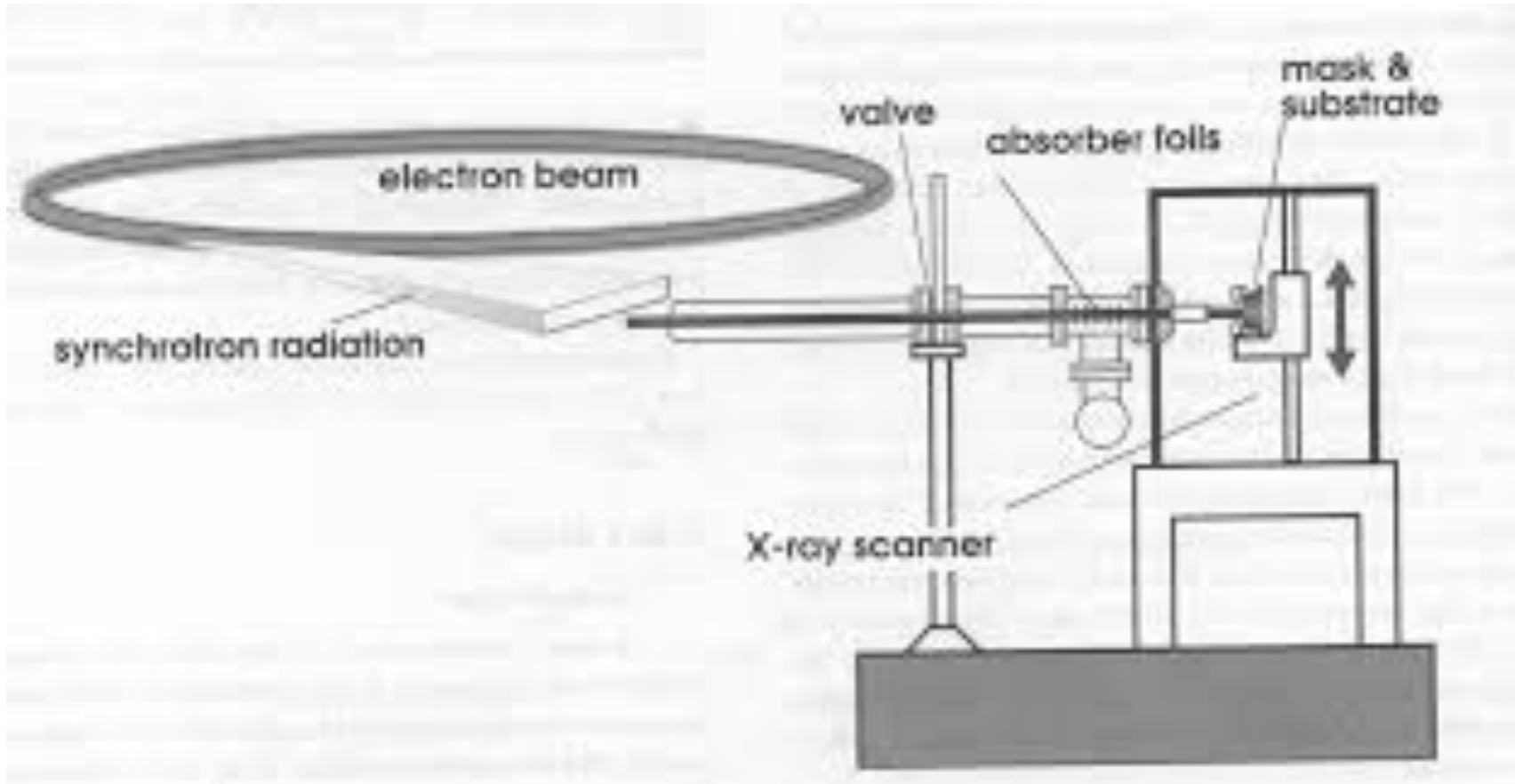

# LIGA

## Mask alignment

Mask-resist alignment is complicated because there is no visible radiation. Then alignment centering holes are created. A capacitive coupling system has also been developed.

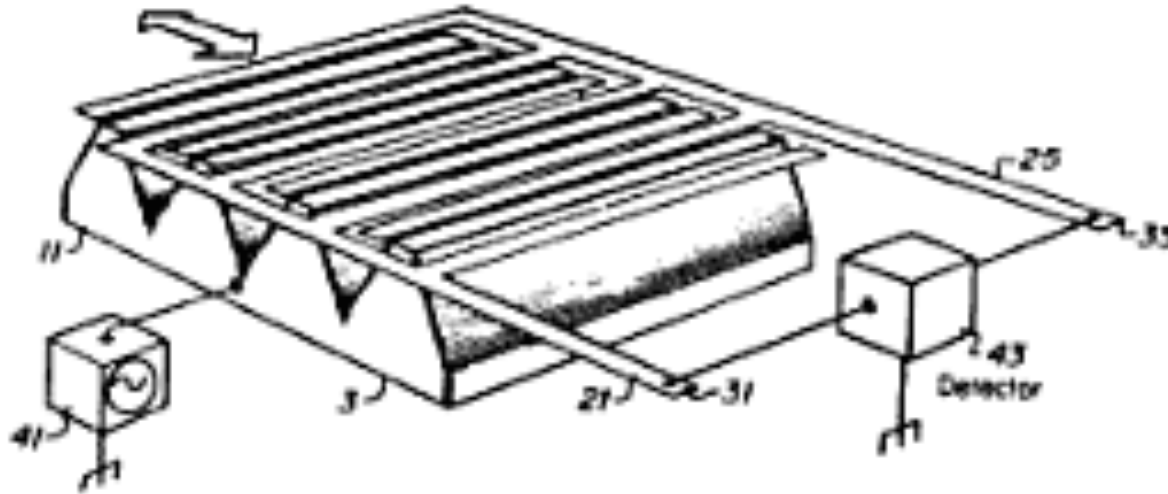

# LIGA

## Altra metodologia per la creazione delle maschere

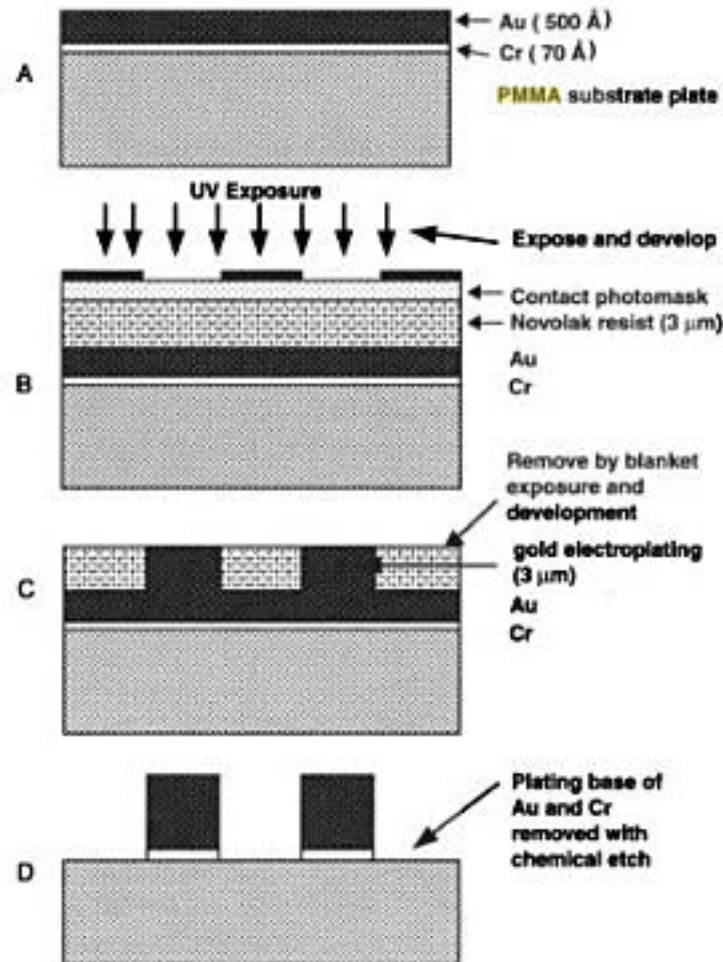

### Passi tecnologici

- 1) Deposizione di cromo su PMMA
- 2) Deposizione di oro su Cromo
- 3) Deposizione di Novolak
- 4) Maschera UV a contatto
- 5) Esposizione agli UV
- 6) Rimozione novolak
- 7) Rimozione oro con soluzione di KI (5%) ed I(1.25%) in acqua
- 8) Rimozione del cromo per etching

# LIGA

## Resist features

The resist must be highly sensitive to X-rays, be resistant to dry and wet etching, stable up to 140 ° C, must adhere well to the working substrate, and be compatible with the electrodeposition process, ie have a glass transition temperature greater than that of the electrolyte, having low internal mechanical stresses.

The material that best meets these requirements is PMMA and its copolymers. Compounds such as polyglycolic lactic acid (PLGA), polymethacrylamide (PMI), polyoxymethylene (PMO) and polyalkensulfone (PAS) were also used.

TABLE 6.7 Properties of Resists for Deep X-Ray Lithography

	PMMA	POM	PAS	PMI	PLG
Sensitivity	-	+	++	0	0
Resolution	++	0	--	+	++
Sidewall smoothness	++	--	--	+	++
Stress corrosion	-	++	+	--	++
Adhesion on substrate	+	+	+	-	+

Note: PMMA = poly(methylmethacrylate), POM = polyoxymethylene, PAS = polyalkensulfone, PMI = polymethacrylamide, PLG = poly(lactide-co-glycolide). ++ = excellent; + = good; 0 = reasonable; - = bad; -- = very bad.

# LIGA

## Resist deposition

- Multiple spin coating (20 micrometers maximum in layer and then thermal annealing)
- Use of commercial sheets of PMMA (> 3mm)
- Casting followed by vacuuming process to eliminate trapped oxygen

To promote adhesion of the resist to the primary metal layer Au / Cr:

- Treatment with methacrylopropyltrimethoxyil (MEMO) (1%) or with hydroxyethyl methacrylate (HEMA) already mixed in PMMA or placed above
- Pressurized with heat treatment

# LIGA exposure

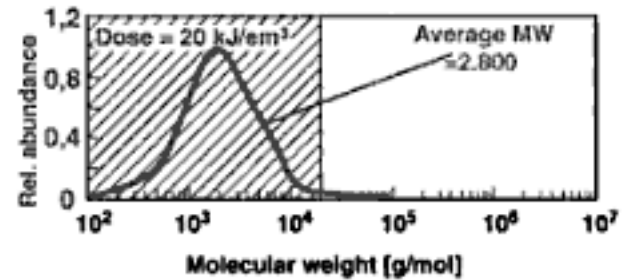
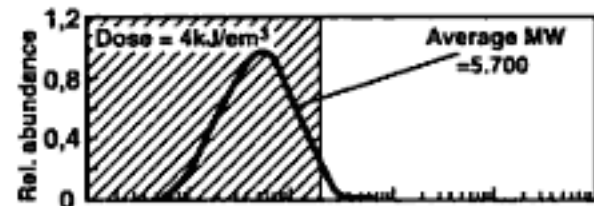
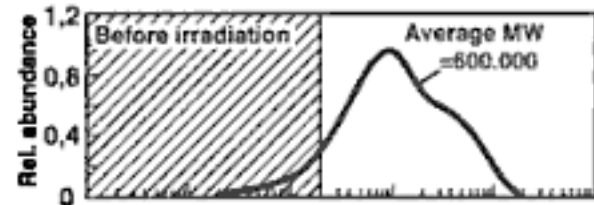
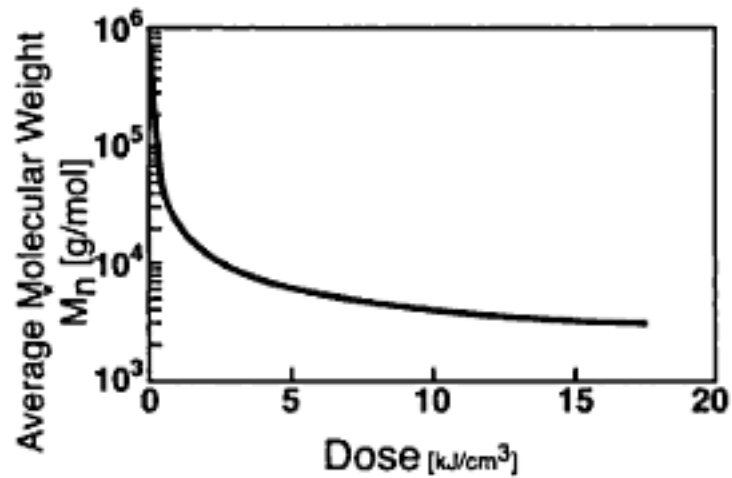

# LIGA

## Development

The developer is composed of 1,4 oxazine 20 vol%, 2-aminoethanol 5 vol%, 2- (2-butoxyethoxy) ethanol 60 vol% and the remaining deionized water.

This developer induces a slow removal of the exposed resist and induces low stress in it.

Because the structures are very deep and thin to be sure to remove all the resist you use fluidic systems that allow the continuous flow of the developer.

The development phase must take place at a controlled temperature of 35 ° C.



# LIGA

## difference between techniques

TABLE 6.9 Comparison of Micromolds

Parameters	LIGA	DUV	DRIE	Laser	CNC	EDM
Aspect ratio	100	22	10–25	<10	14 (drilling)	Up to 100
Wall roughness	<20 nm	~1 $\mu\text{m}$	~2 $\mu\text{m}$	1 $\mu\text{m}$ –100 nm	Several microns	0.3–1 $\mu\text{m}$
Accuracy	<1 $\mu\text{m}$	2–3 $\mu\text{m}$	<1 $\mu\text{m}$	A few microns	See Figure 7.2 (x,y only)	Some microns
Mask needed?	Yes	Yes	Yes	No	No	No
Maximum height	A few 100 $\mu\text{m}$ up to 1 cm	A few 100 $\mu\text{m}$	A few 100 $\mu\text{m}$	A few 100 $\mu\text{m}$	Unlimited	Microns to millimeters

\*Except for mask needs, all entries strongly depend on the exact intended geometry.

Source: L. Weber, W. Ehrfeld, H. Freimuth, M. Lacher, H. Lehr, and P. Pech, in *SPIE, Micromachining and Microfabrication Process Technology II*, Austin, Texas, 1996, pp. 156–67.<sup>24</sup> Reprinted with permission.

# LIGA

## Metallization

- Metallization without electrode
- Electrodeposition

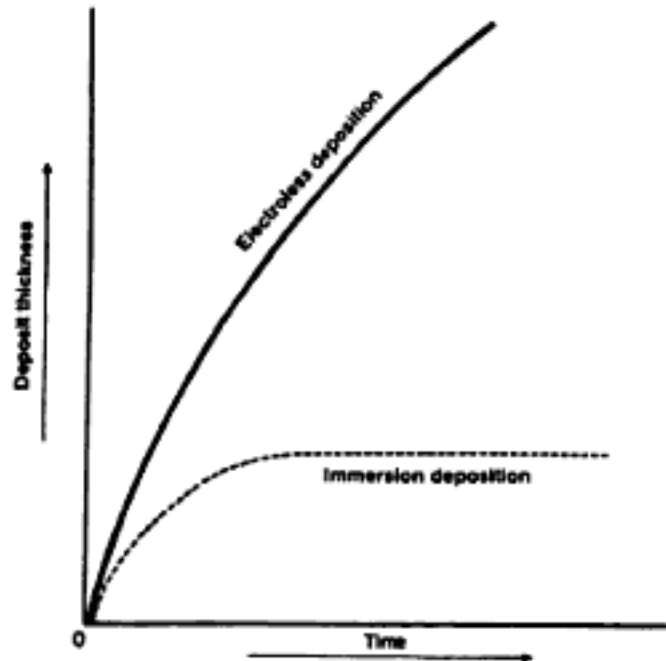

# LIGA

## Metalization without electrode

This process through a continuous process of oxidation reduction where electrons are supplied by hypophosphites. The reaction until the hypophosphite is consumed. The deposition is not controlled but also occurs on the walls of the container. Then lead compounds are added to make the reaction stable and preferably on the substrate.

Reduction:

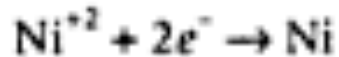

Oxidation:

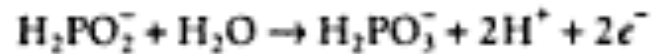

Overall reaction:

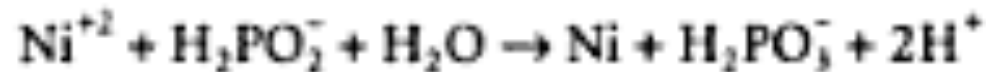

# LIGA

## Electrodeposition

Initially, in order to have electrodeposition, a slight passage of metal sputtering is carried out on the microprocessed substrate at UV between 50 and 100 Å. Then the system is placed in an electrochemical cell with  $\text{NiCl}_2$  bath in  $\text{KCl}$  solution and a graphite anode is used which is not attached by  $\text{Cl}_2$ . In this way, Ni is deposited once a high voltage is applied between the two electrodes. We must be careful that changes in pH can alter the deposition and that the presence of powders or contaminants does not allow an adequate and uniform deposition.

The metal deposition materials generally used are

Nickel

Copper

Gold

# LIGA metallization

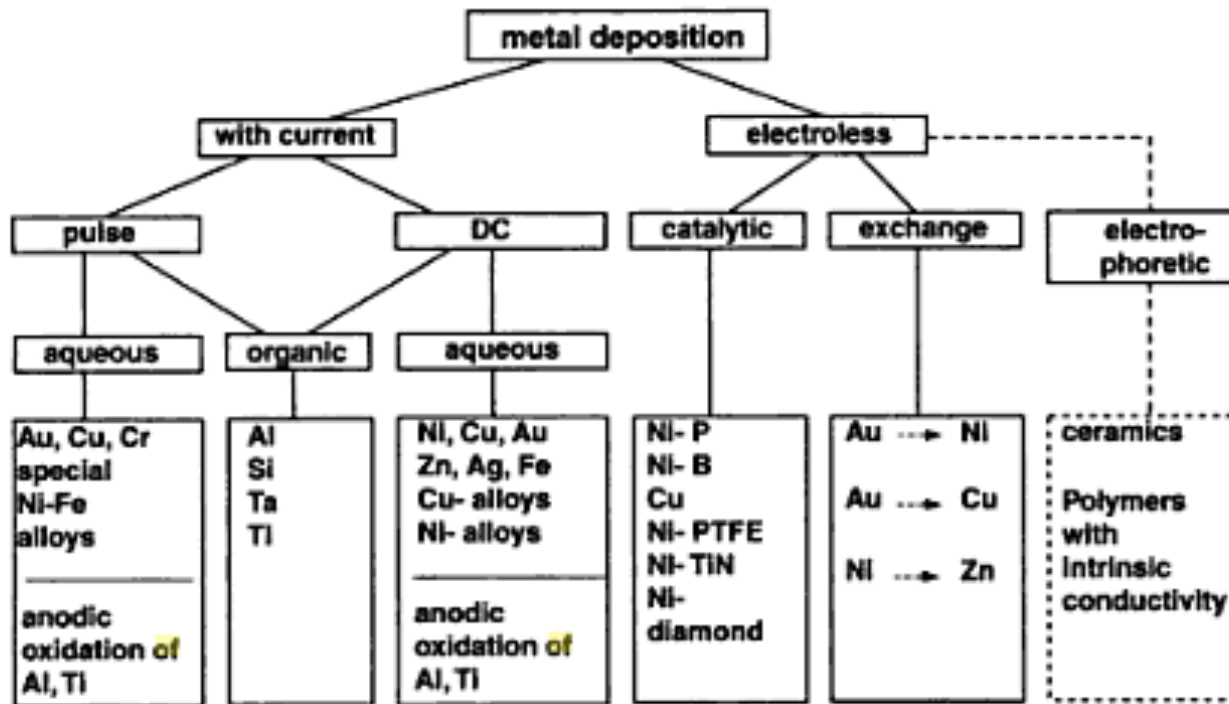

The finish of the metal mold is obtained by process of plasma oxygen or bath in solvent

# **LIGA**

## **Molding**

- **Reaction injection molding**
- **Transfer molding**
- **Casting**

# LIGA

## Reaction injection molding

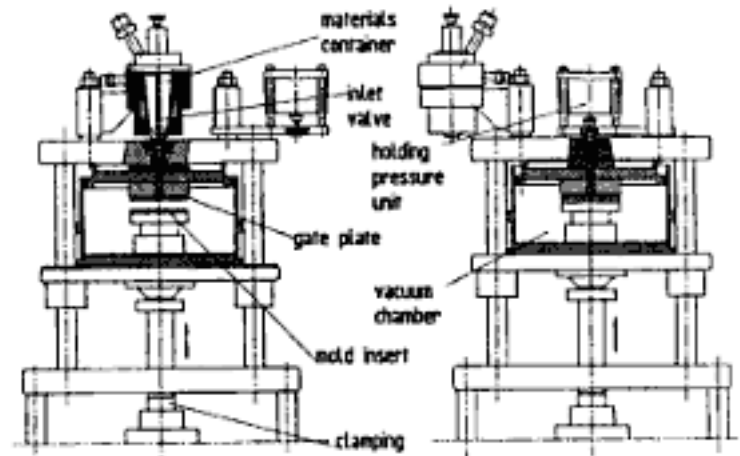
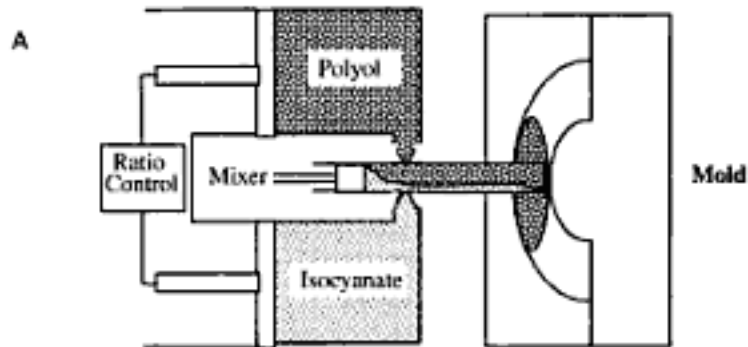

Figure 6.35 Schematic presentation of a vacuum molding setup. With minor changes, this setup can be used for reaction injection molding, thermoplastic injection molding, and compression molding. (After P. Hagemann, *J. Polymer Process. Soc.*, 4, 188-95, 1988.<sup>59</sup>)

# LIGA

## Transfer injection molding

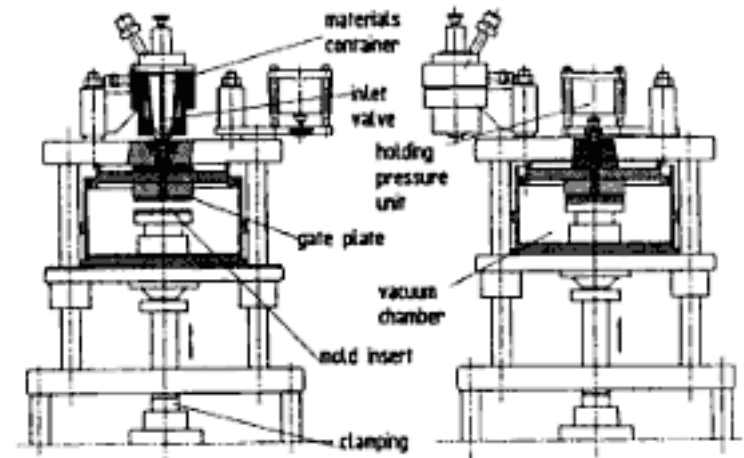
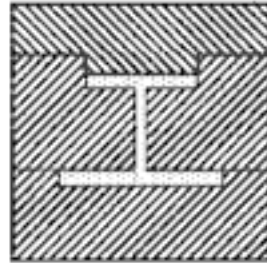
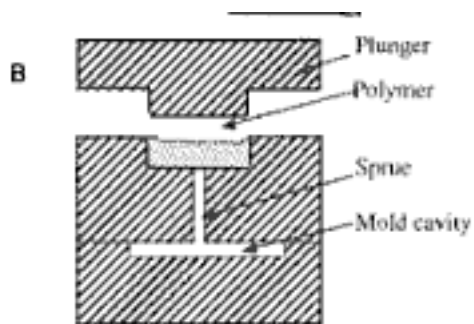
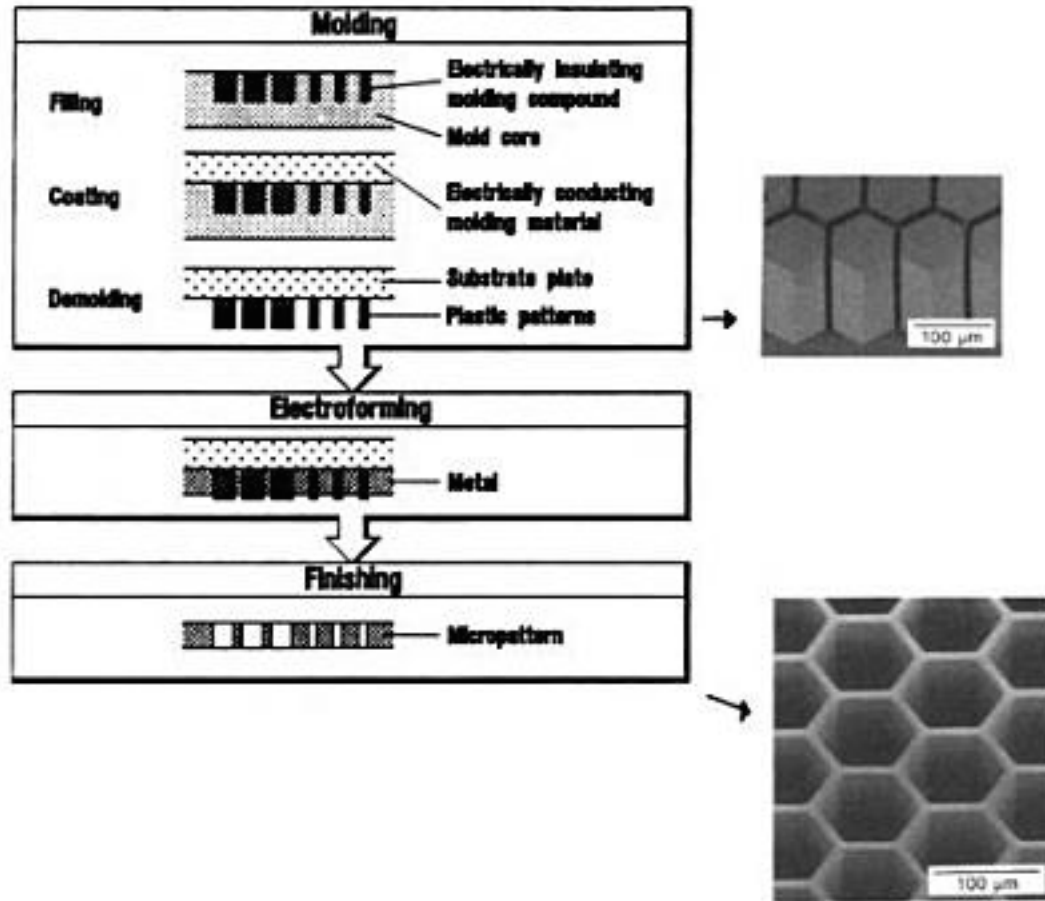

Figure 6.35 Schematic presentation of a vacuum molding setup. With minor changes, this setup can be used for reaction injection molding, thermoplastic injection molding, and compression molding. (After P. Hagemann, *J. Polymer Process. Soc.*, 4, 188–95, 1988.<sup>53</sup>)



# LIGA

## Injection Molding



# LIGA

## Injection Molding

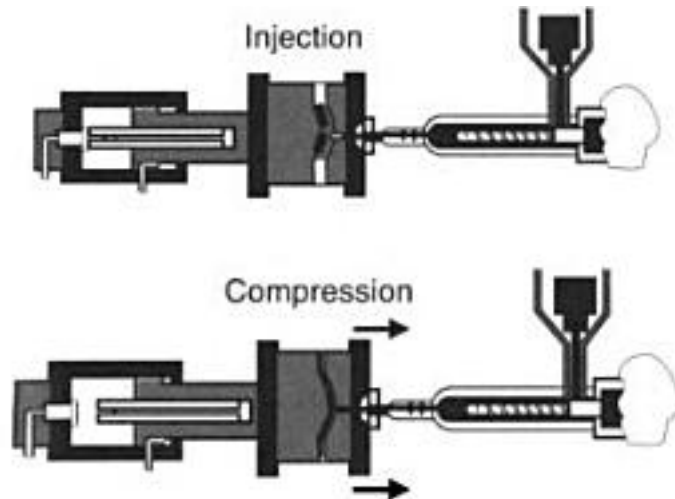
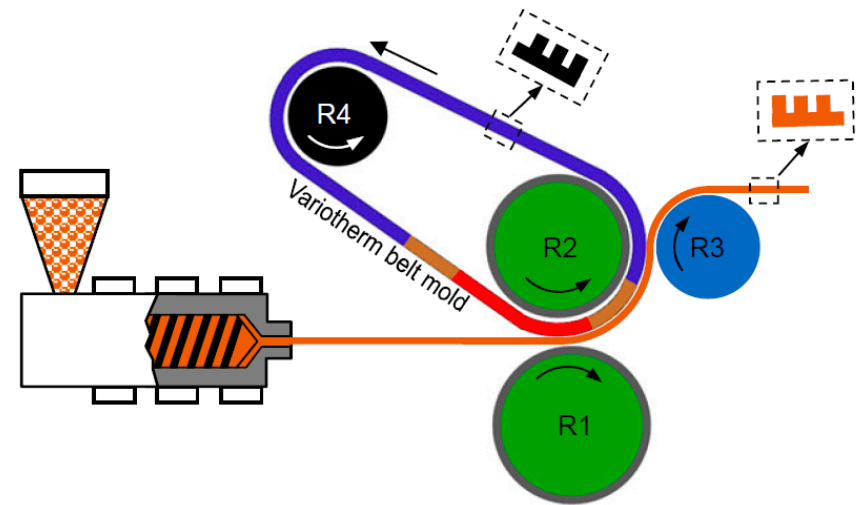
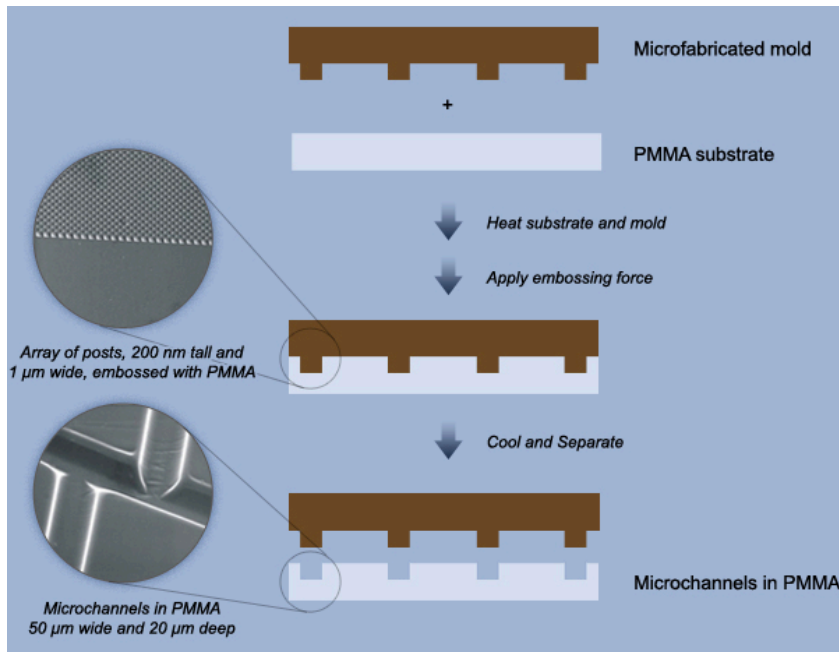

**TABLE 6.16** Typical Conditions **for** Injection Molding

Mold temperature	85°C
Polycarbonate temperature	330°C
Clamping force	60 tons
Injection time	1 s
Cooling time	2 s

# LIGA

## cyclic and continuous Hot embossing



# LIGA

## Demolding

For the demolding phase or removing agents are mixed directly with the polymer to be injected or sprayed with the spray technique on the mold.

In general clamping systems are used which grasp the piece to be removed in order to distribute the extraction force uniformly.

# LIGA

## example

Electromagnetic engine

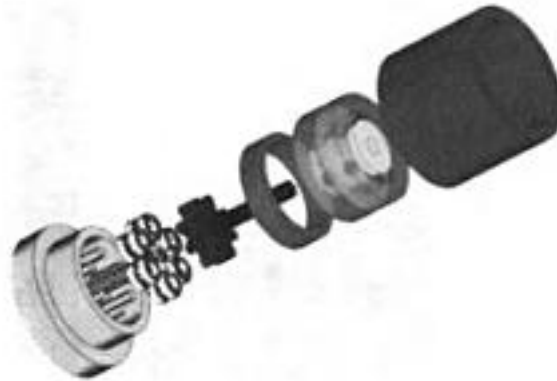

A

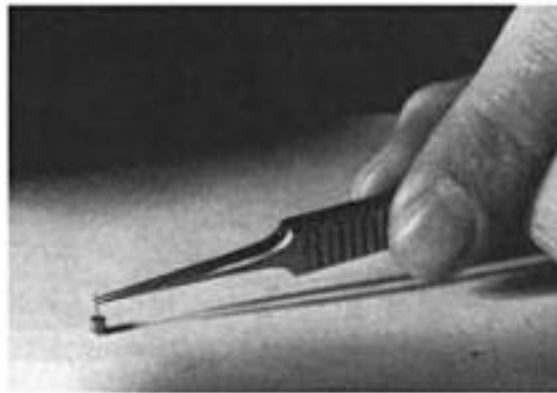

B

# LIGA

## example

### Spinneret

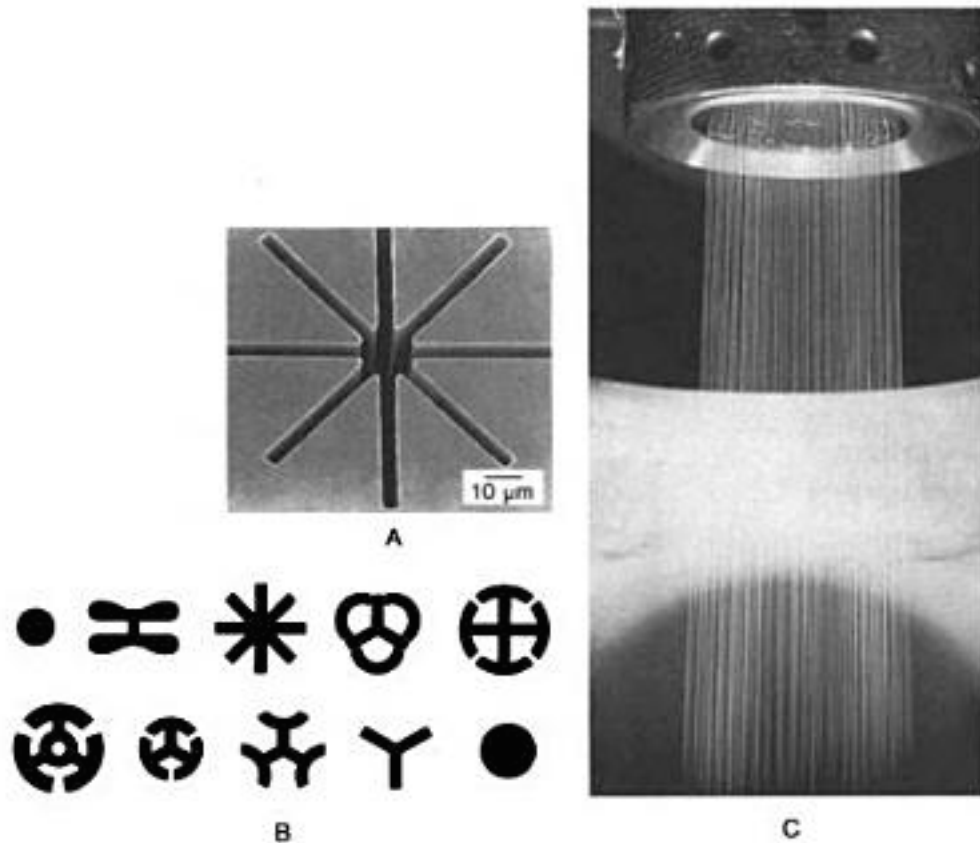

**Figure 6.52** LIGA spinneret nozzles. (A) Spinneret plate; (B) profiled spinneret nozzles; (C) spinning synthetic fiber. (Courtesy of IMM, Germany.)