

**Laboratorio di
Tecnologie Biomediche
*Tecnologie di fabbricazione***

Carmelo De Maria
carmelo.demaria@unipi.it

Building 3D objects

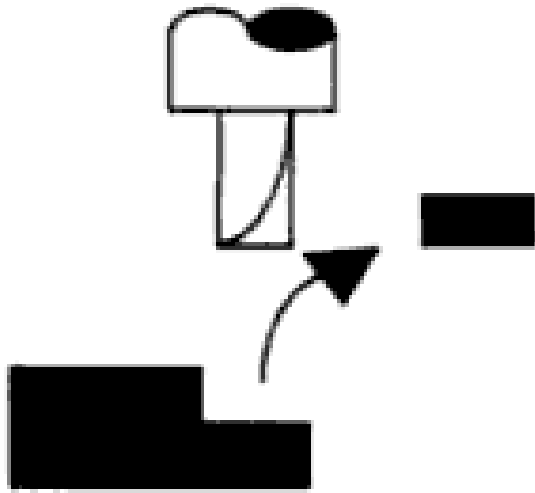

Subtractive

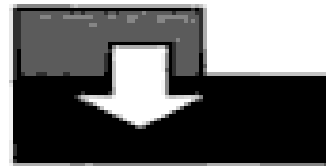

Additive

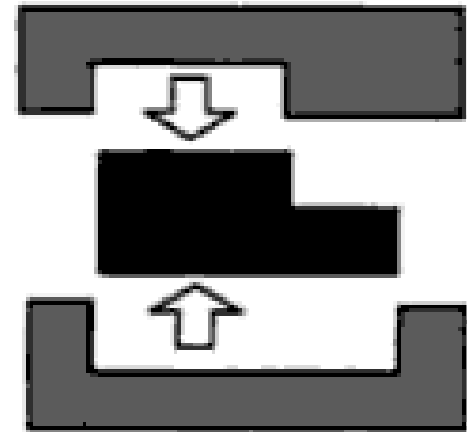

Formative

Building 3D objects: subtractive

- Milling
- Turning
- Drilling
- Planning
- Sawing
- Grinding
- EDM
- Laser cutting
- Water jet cutting
- ...



Building 3D objects: formative

- Bending
- Forging
- Electromagnetic forming
- Plastic injection molding
- ...



Building 3D objects: additive

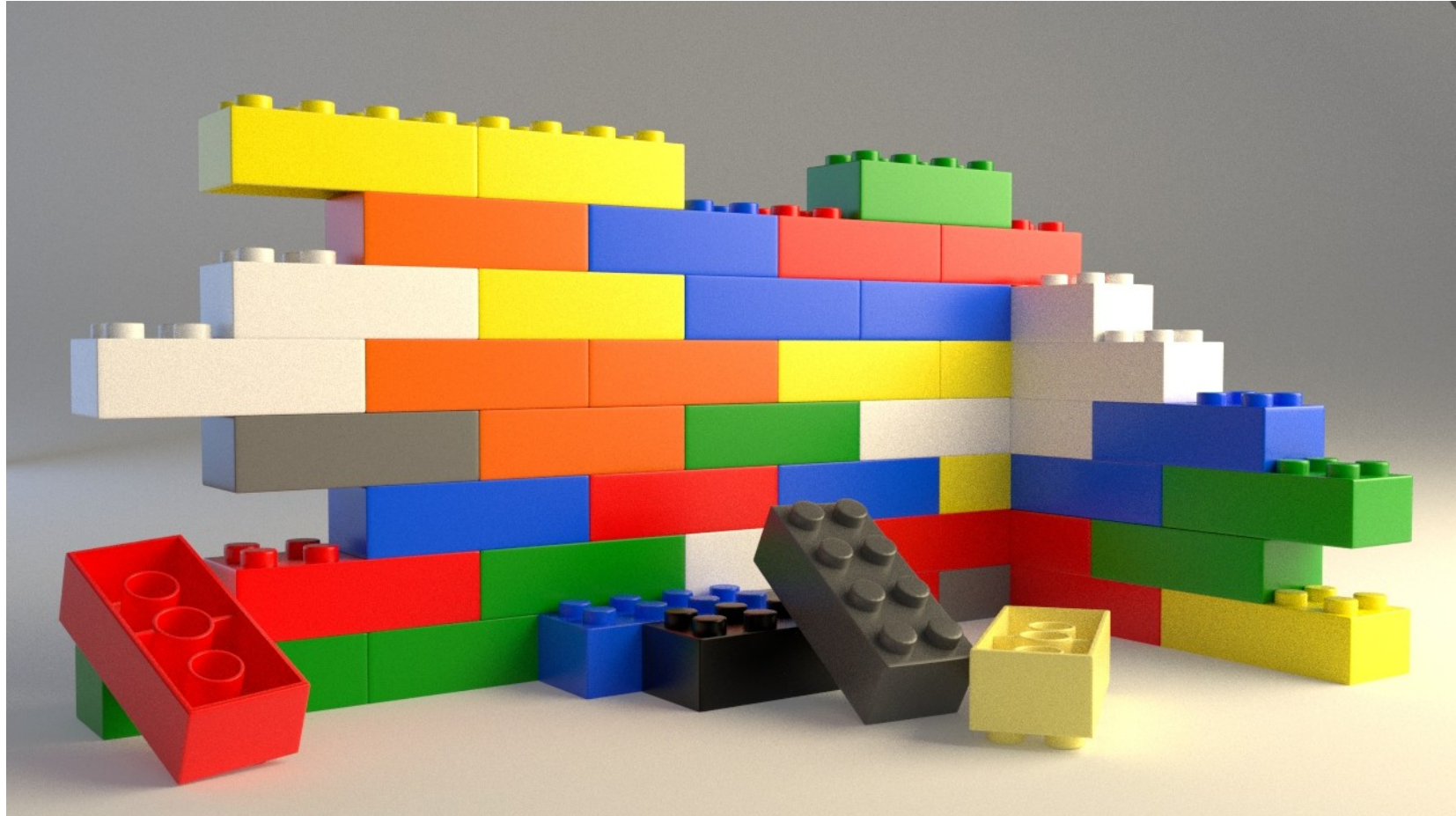

Additive manufacturing

- Additive manufacturing is a process of making a 3D solid object of virtually any shape **from a digital model**.
- It is achieved using an additive process, where successive layers of material are laid down in different shapes.

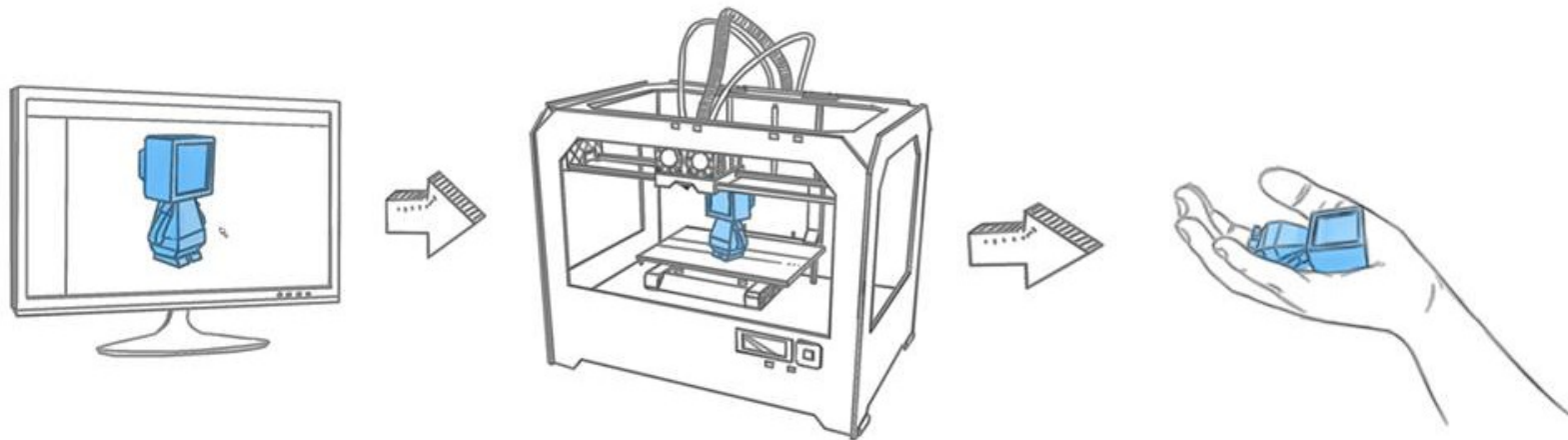

Additive manufacturing for Rapid prototyping

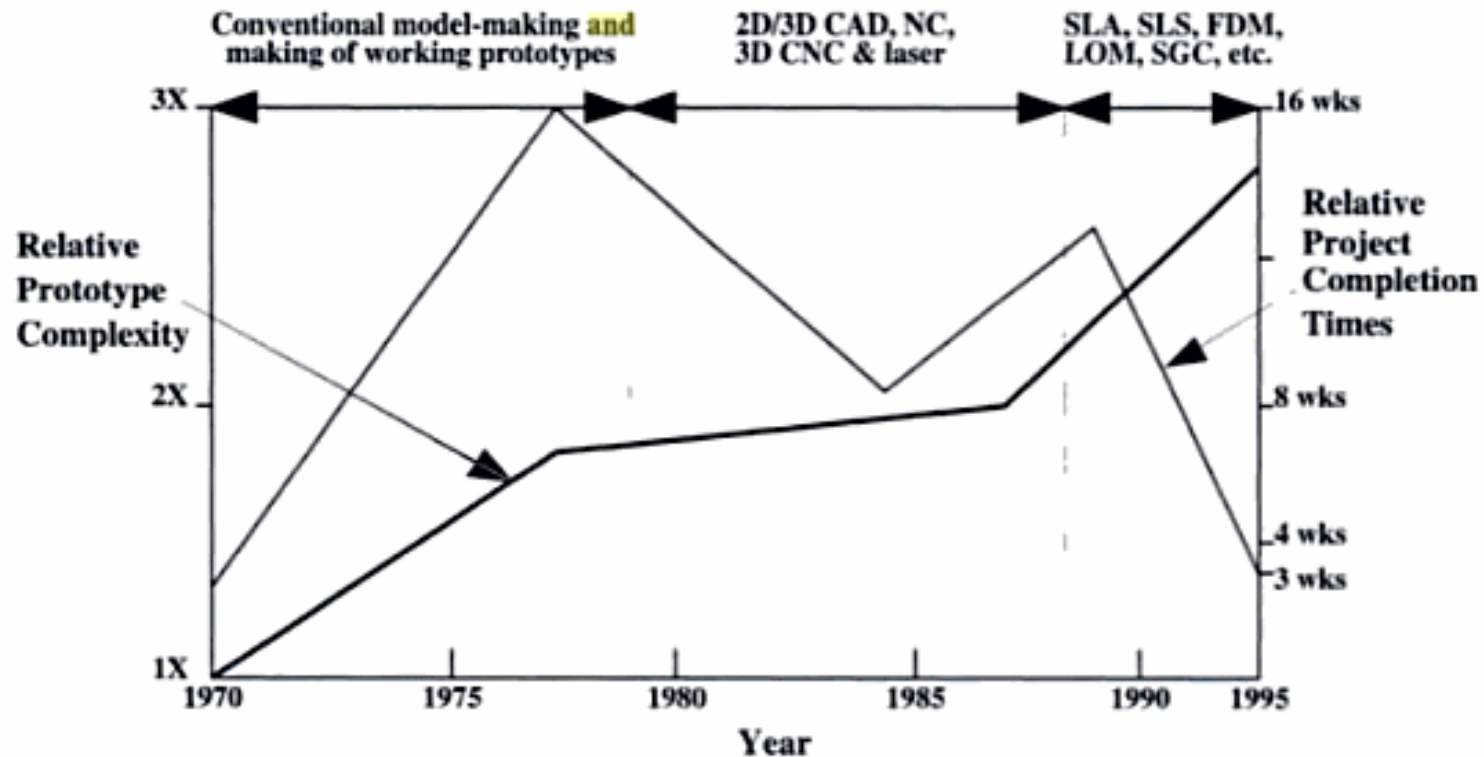

Additive manufacturing by Industry sectors

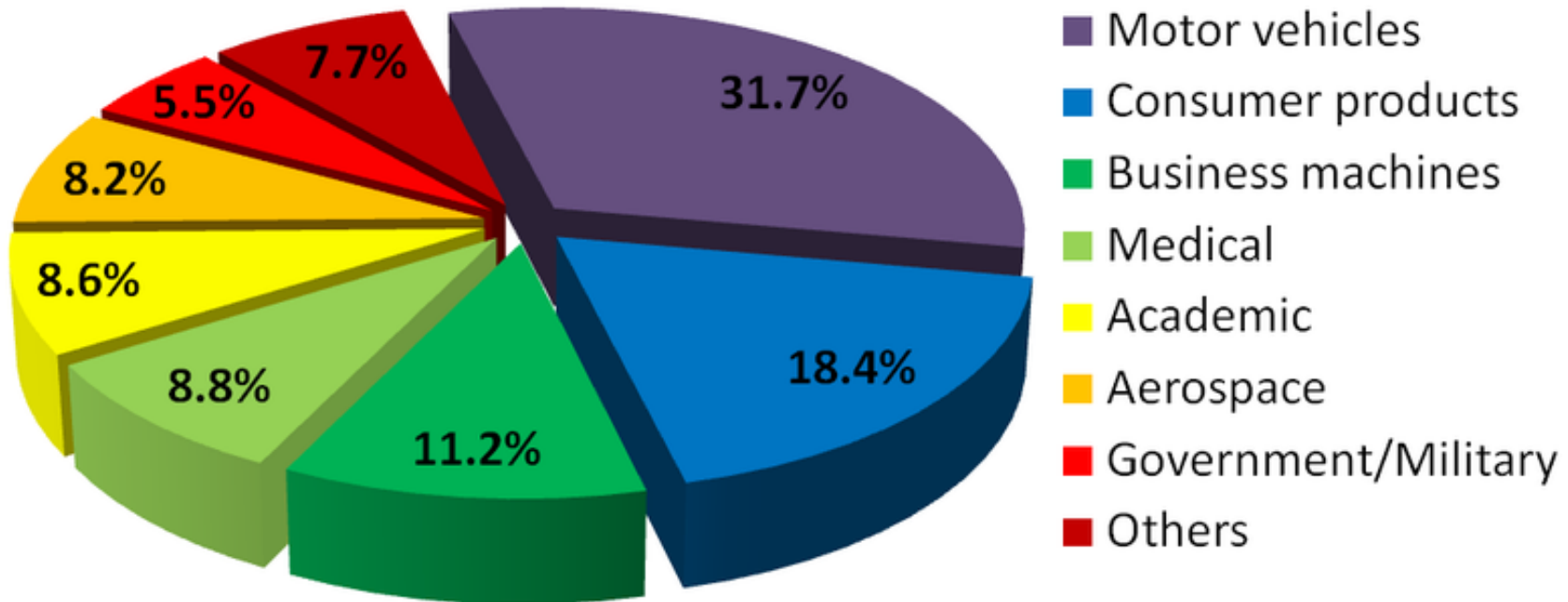

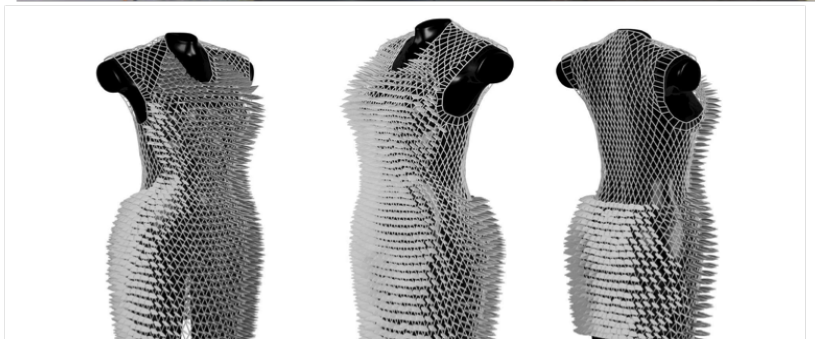
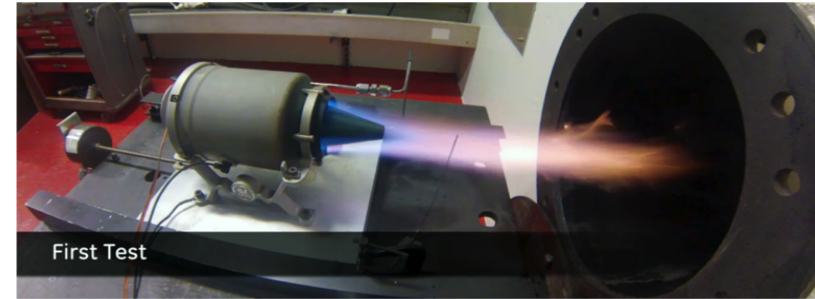
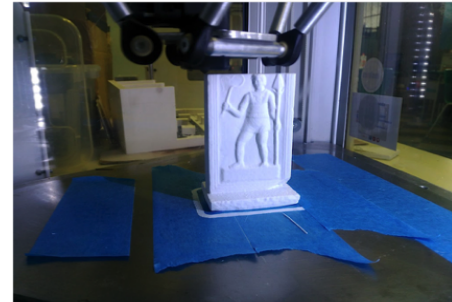
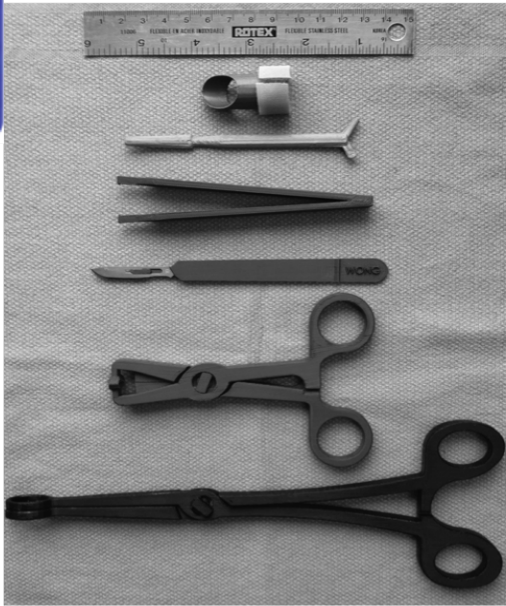
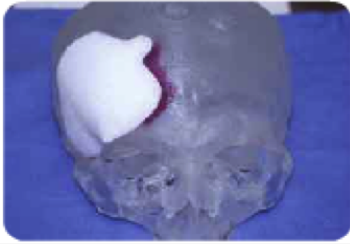
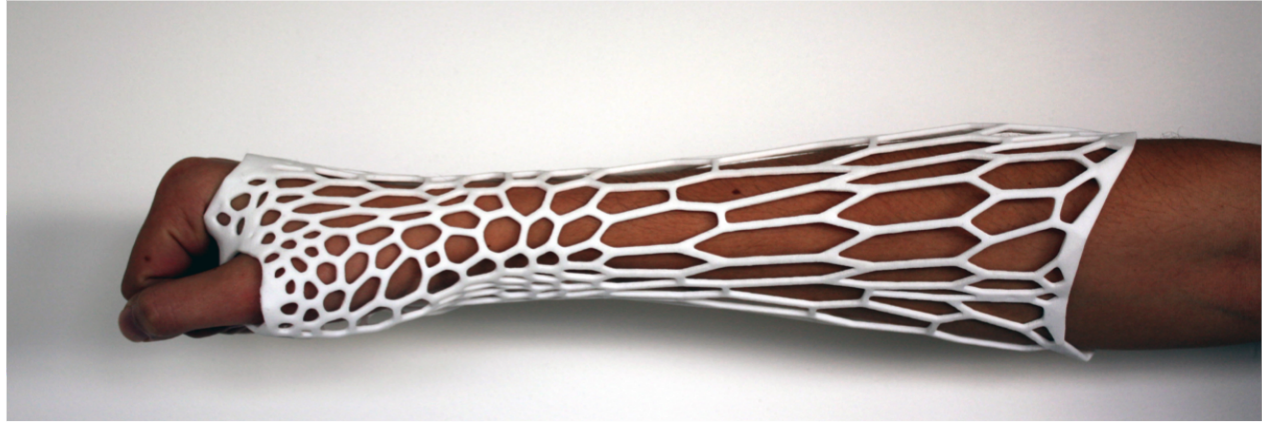

Computer Aided technologies (CAx)

- CAD – Design
- CAE – Engineering
- CAM – Manufacturing
- CAPP – Process Planning
- CIM – Computer Integrated Manufacturing

Hype cycle 2013

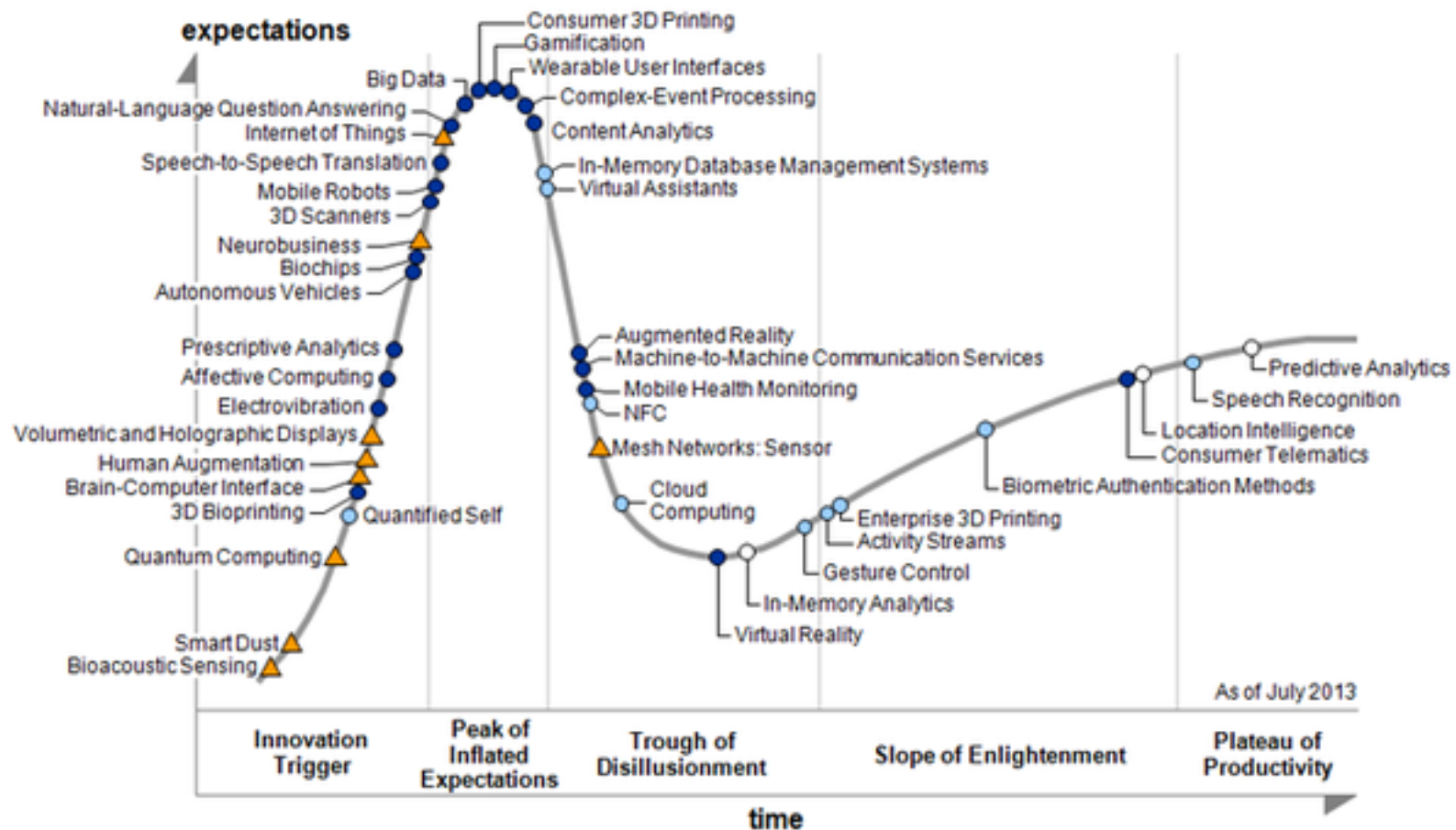

Hype cycle 2015

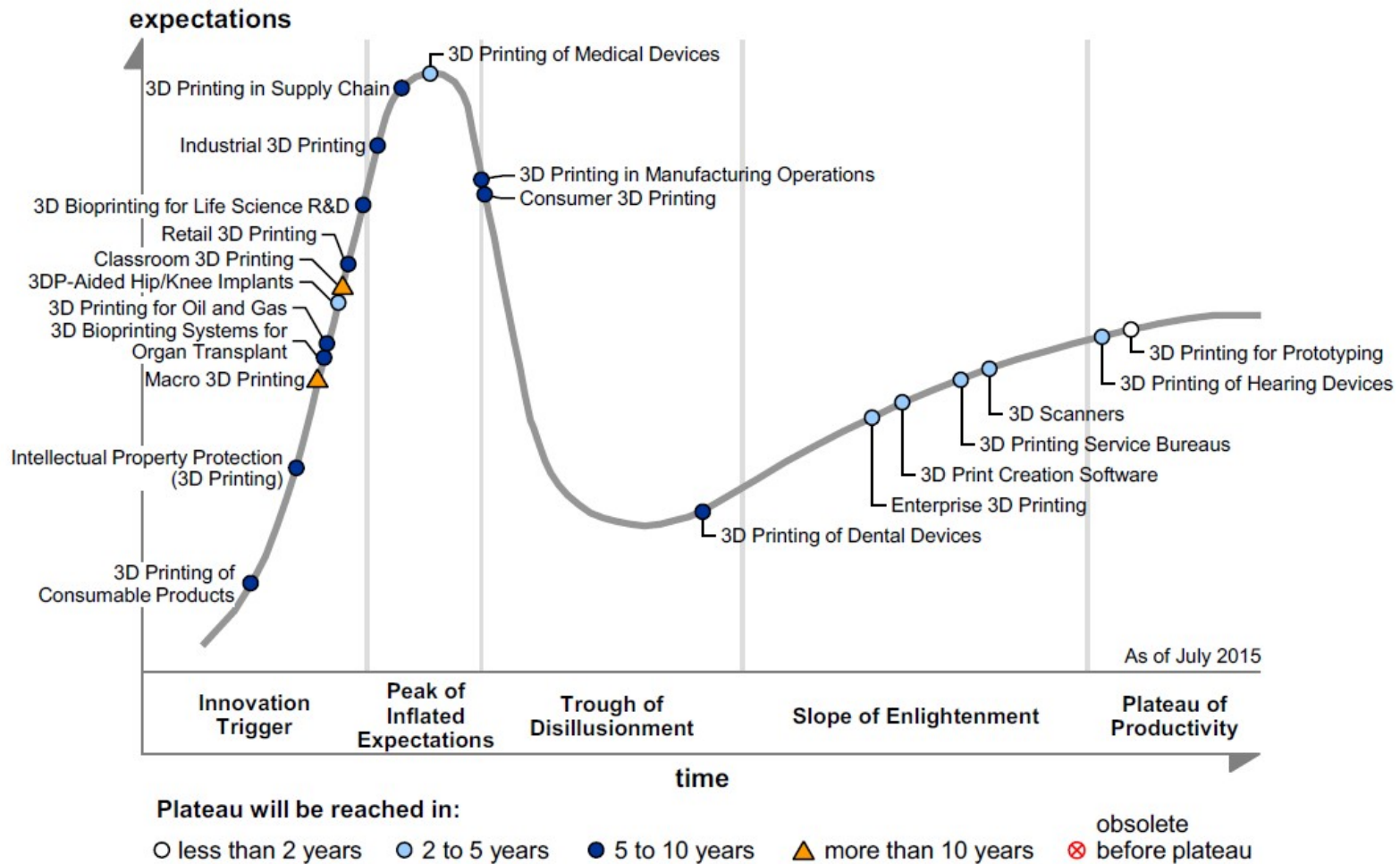

Source: Gartner (July 2015)

A possible classification

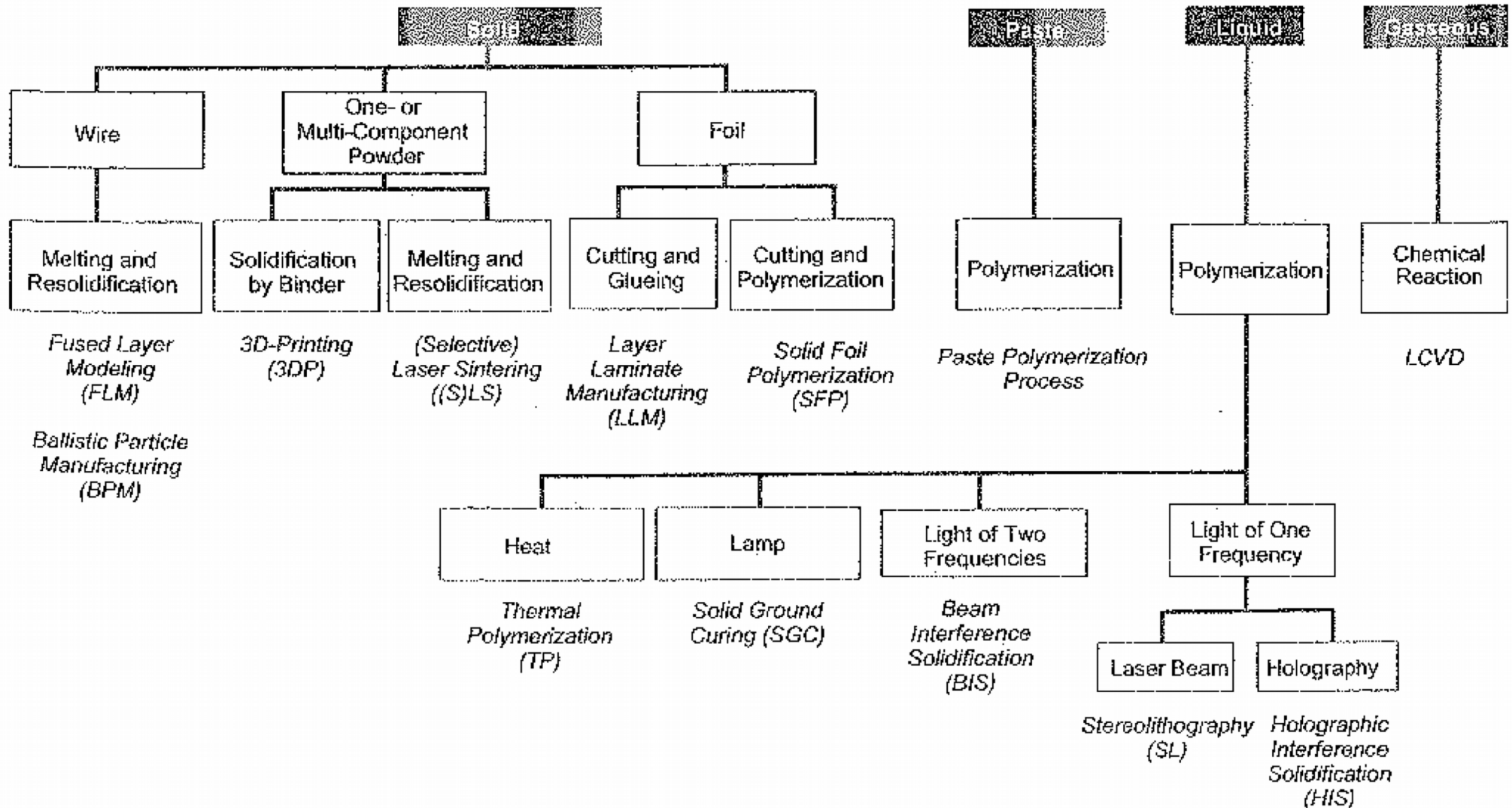

Available technologies

- Solidification of liquid materials
 - Photo-polymerization process

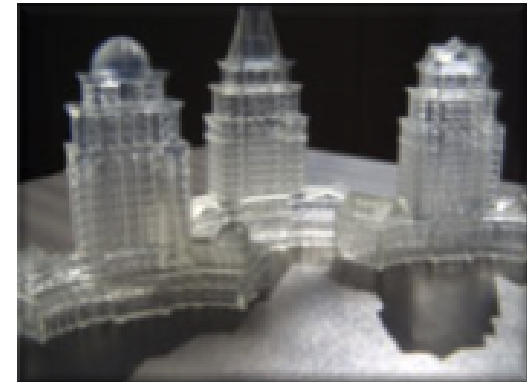
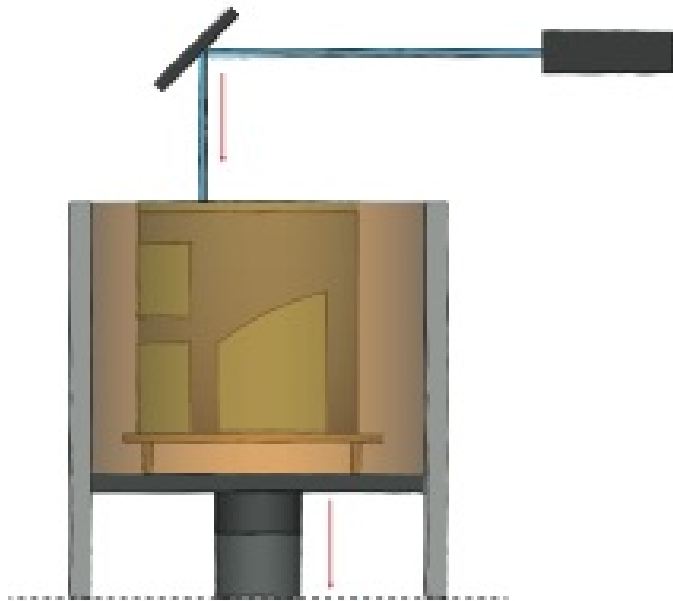

Stereolithography

- <https://www.youtube.com/watch?v=Nm55ct5Kwil>

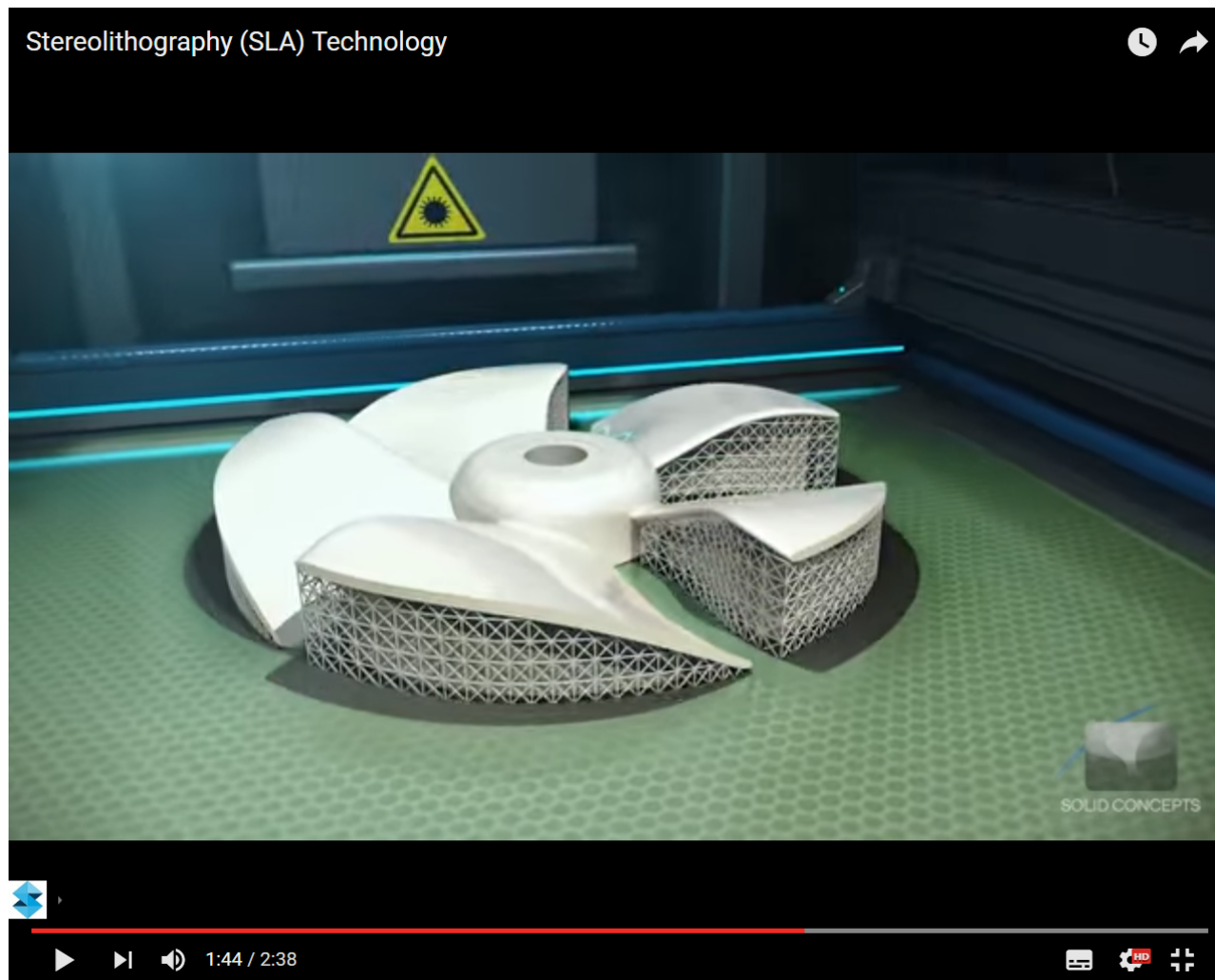

Stereolithography: options

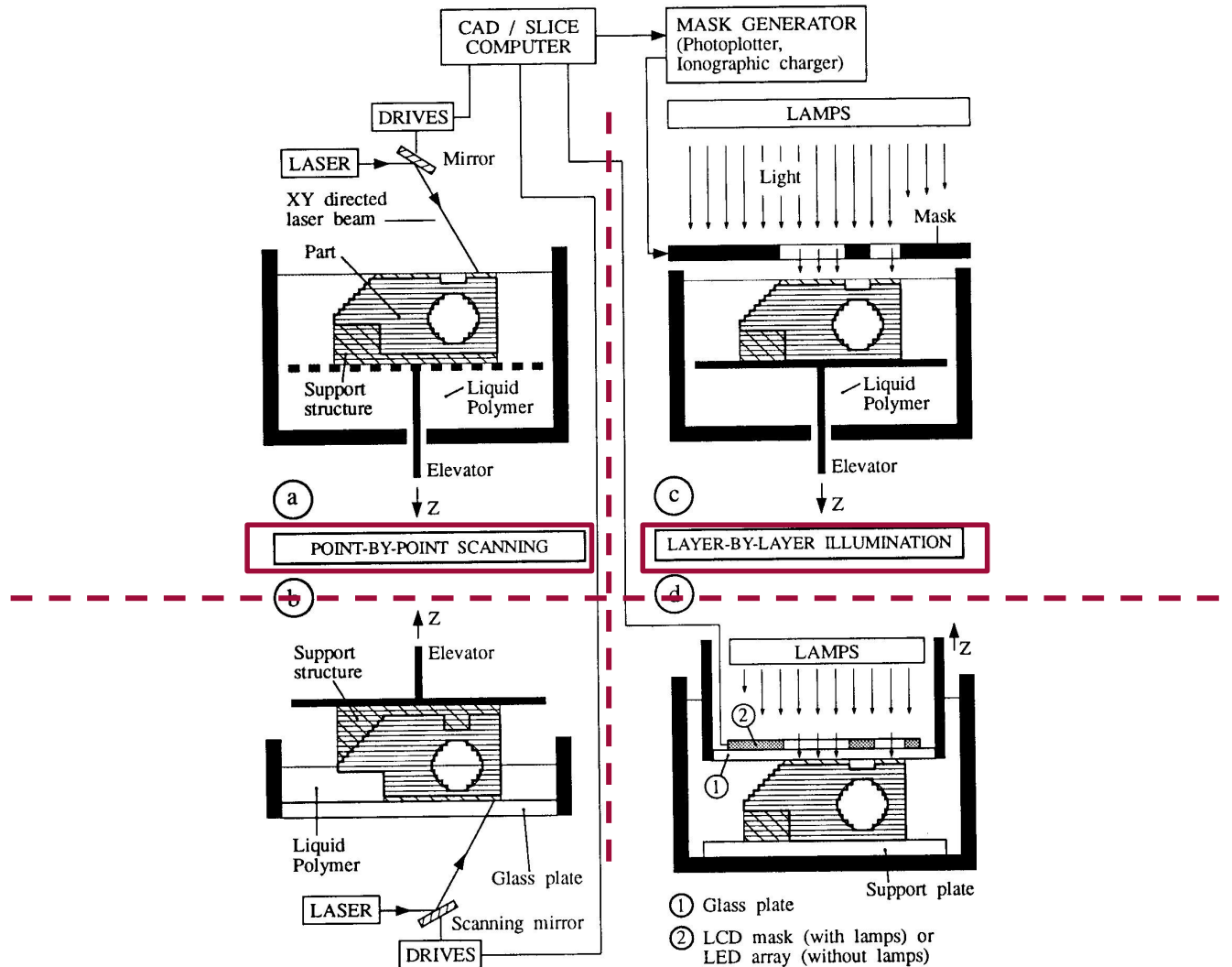

3D System SLA 7000

Laser	He-Cd
Wavelength	0.325 μm
Power	800 mW
Minimum layer	0.025 mm
Building volume	500 x 500 x 600 mm ³
Scan speed	Max 9.52 m/s
Spot diameter	From 0.23 to 0.84 mm



Materials: Somos 18120

TECHNICAL DATA							
Mechanical Properties		Somos® ProtoGen 18120 UV Postcure at HOC -2		Somos® ProtoGen 18120 UV Postcure at HOC +3		Somos® ProtoGen 18120 UV & Thermal Postcure	
ASTM Method	Property Description	Metric	Imperial	Metric	Imperial	Metric	Imperial
D638M	Tensile Strength	51.7 - 54.9 MPa	7.5 - 8.0 ksi	56.9 - 57.1 MPa	8.2 - 8.3 ksi	68.8 - 69.2 MPa	9.9 - 10.0 ksi
D638M	Tensile Modulus	2,620 - 2,740 MPa	381 - 397 ksi	2,540 - 2,620 MPa	370 - 380 ksi	2,910 - 2,990 MPa	422 - 433 ksi
D638M	Elongation at Break	6 - 12%	6 - 12%	8 - 12%	8 - 12%	7 - 8%	7 - 8%
D638M	Poisson's Ratio	0.43 - 0.45	0.43 - 0.45	N/A	N/A	0.43	0.43
D790M	Flexural Strength	81.8 - 83.8 MPa	11.9 - 12.2 ksi	83.8 - 86.7 MPa	12.2 - 12.6 ksi	88.5 - 91.5 MPa	13.2 ksi
D790M	Flexural Modulus	2,360 - 2,480 MPa	343 - 359 ksi	2,400 - 2,450 MPa	350 - 355 ksi	2,330 - 2,490 MPa	361 ksi
D2240	Hardness (Shore D)	84 - 85	85 - 87	N/A	N/A	87 - 88	87 - 88
D256A	Izod Impact (Notched)	0.14 - 0.26 J/m	0.26 - 0.49 ft-lb/in	N/A	N/A	0.13 - 0.25 J/m	0.24 - 0.47 ft-lb/in
D570-98	Water Absorption	0.77%	0.77%	N/A	N/A	0.75%	0.75%

Materials: Somos 18120

TECHNICAL DATA - LIQUID PROPERTIES	
Appearance	Translucent
Viscosity	~300 cps @ 30°C
Density	~1.16 g/cm ³ @ 25°C

TECHNICAL DATA - OPTICAL PROPERTIES		
E _c	6.73 mJ/cm ²	[critical exposure]
D _p	4.57 mils	[slope of cure-depth vs. ln (E) curve]
E ₁₀	57.0 mJ/cm ²	[exposure that gives 0.254 mm (.010 inch) thickness]

Materials: Somos 18120

$$C_d = D_p \ln\left(\frac{E}{E_c}\right)$$

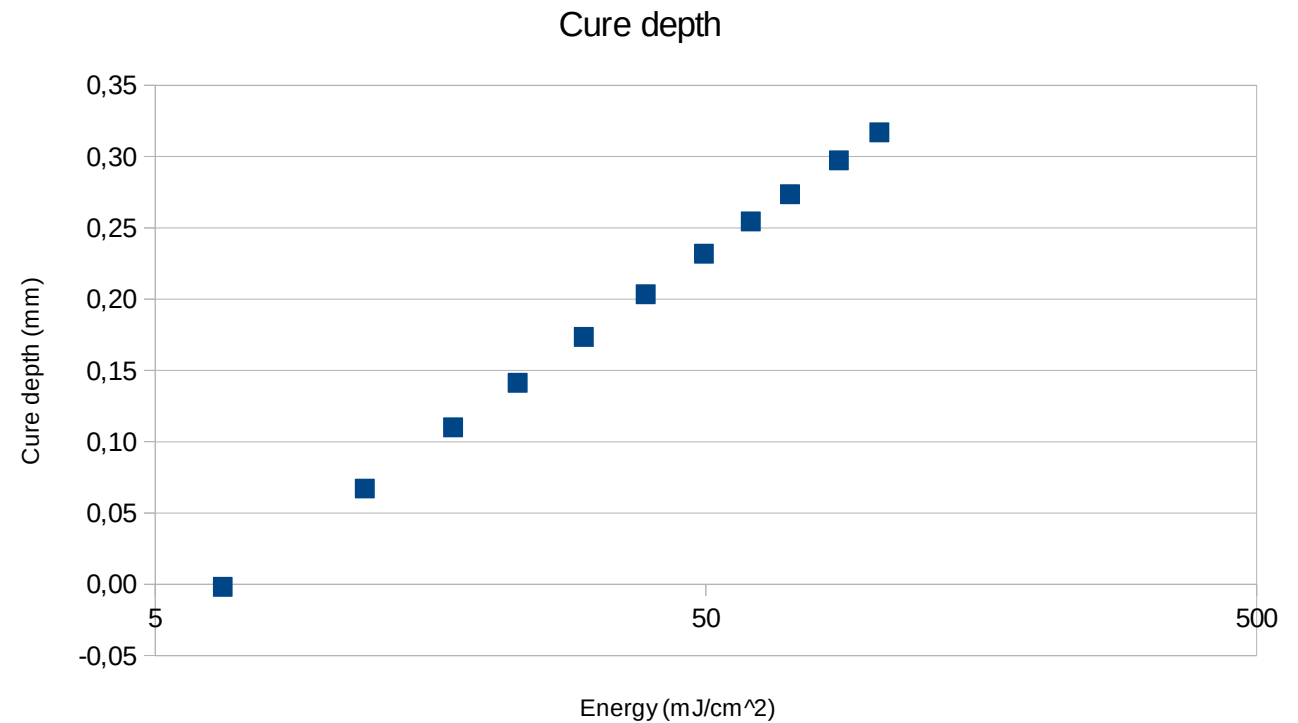

Cost

- Cost of materials:
 - 200€ per liter
 - A cube $20*20*20$ cm³ approx 8 liters
- Post processing Requirements:
 - Careful practices are required to work with the resins.
 - Frameworks must be removed from the finished part.
 - Alcohol baths then Ultraviolet ovens are used to clean and cure the parts.

Pros

- Probably the most accurate functional prototyping on the market.
 - Layer thickness (from 20 to 150 μm)
 - Minimum feature size 80 to 300 μm
 - Smooth surface finish, high dimensional tolerance, and finely detailed features (thin-walls, sharp corners, etc...)
- Large build volume
 - Up to 50 x 50 x 60 cm³ (approx)
- Used in: Investment Casting, Wind Tunnels, and Injection Molding as tooling
- Resins can be custom engineered to meet different needs: higher-temps, speed, finish...

Cons

- Requires post-curing.
 - Long-term curing can lead to warping.
 - Parts are quite brittle and have a tacky surface.
 - Support structures are typically required.
 - Supports must be removed by hand
 - Uncured material is toxic.
- Little material choice
- Costs
 - Material
 - trained operator
 - Lab environment necessary (gasses!)
 - Laser lasts 2000hrs, costs \$20000!
- Slow process

Carbon 3D

Continuous Liquid Interface Production

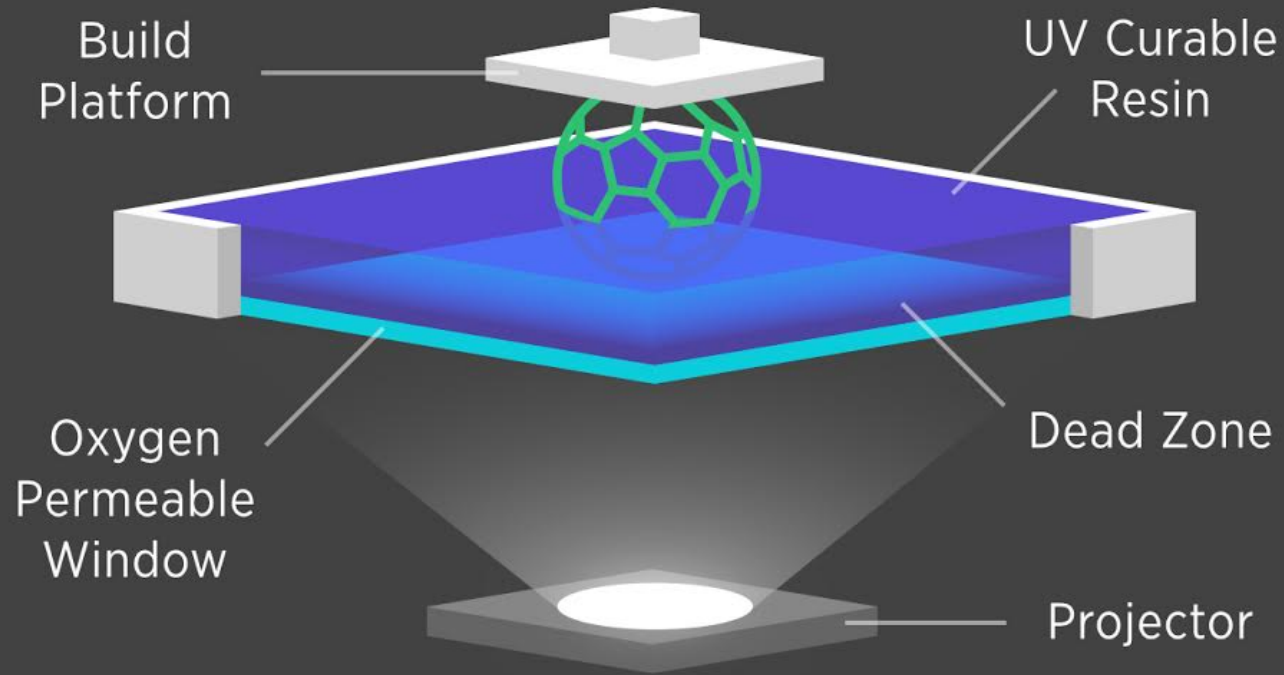

Carbon 3D

- <https://www.youtube.com/watch?v=UpH1zhUQY0c>

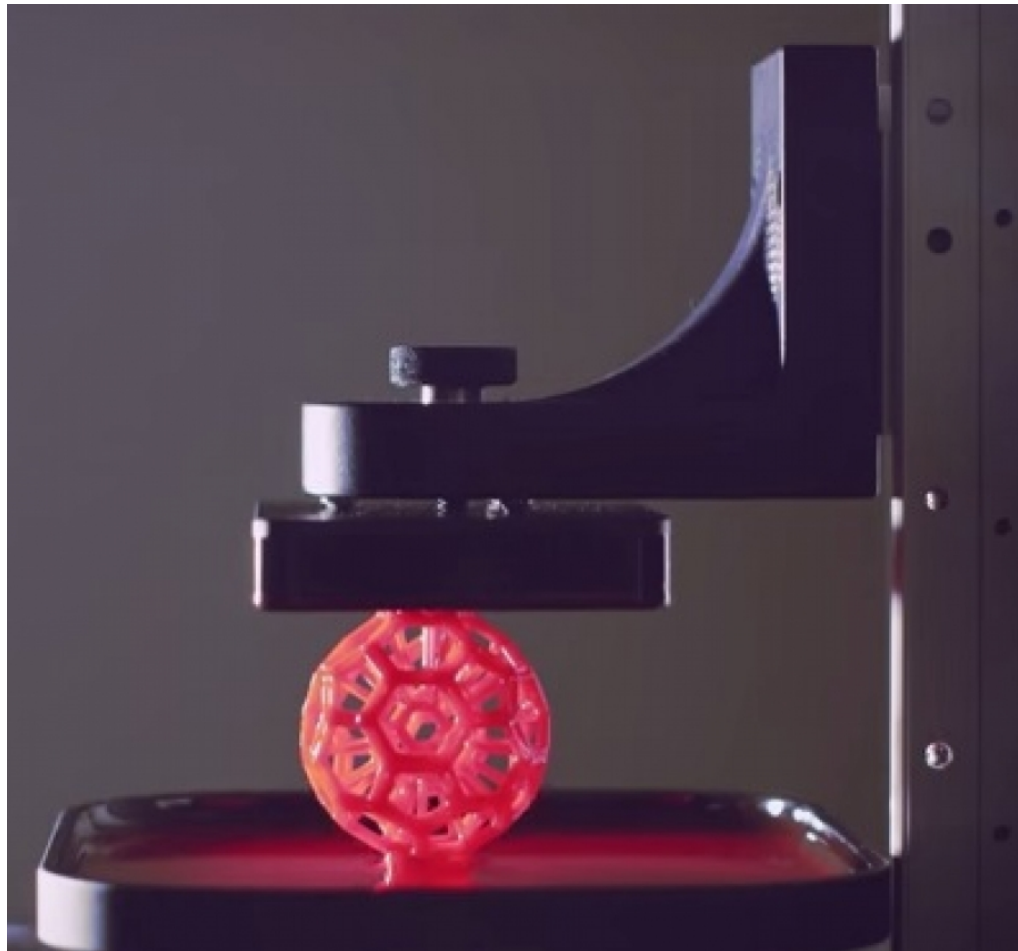

Inkjet technologies

- The ink-jet technology is a contact free dot matrix printing procedure. Ink is issued from a small aperture directly onto a specific position on a medium

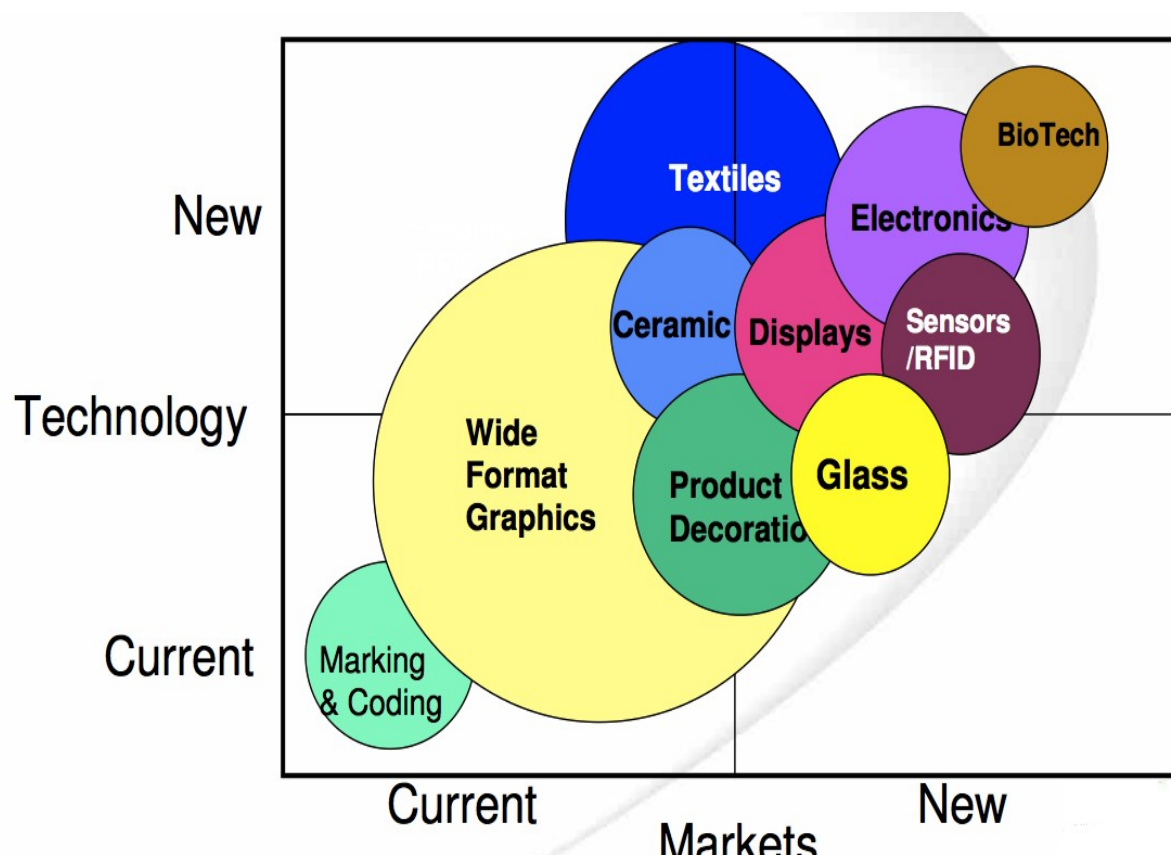

Polyjet

- <https://www.youtube.com/watch?v=Som3CddHfZE>



Available technologies

- Generation from the solid phase:
 - Conglutination of granules or powders by additional binders
 - 3D inkjet printer
- incipiently or completely melted solid materials, powder, or powder mixtures:
 - Ballistic
 - Sintering processes
 - Extrusion (FDM),



Generation from the solid phase

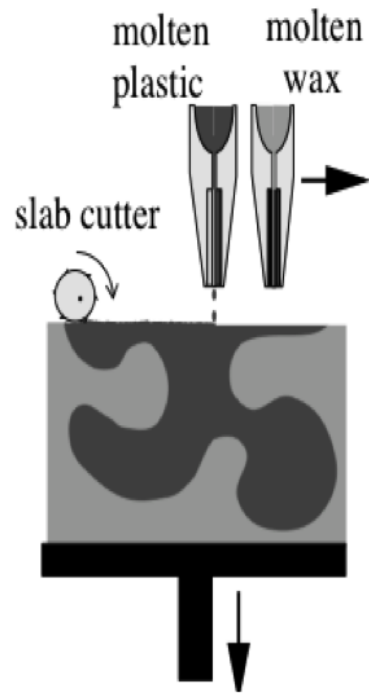

Multijet modeling
(Ballistic)

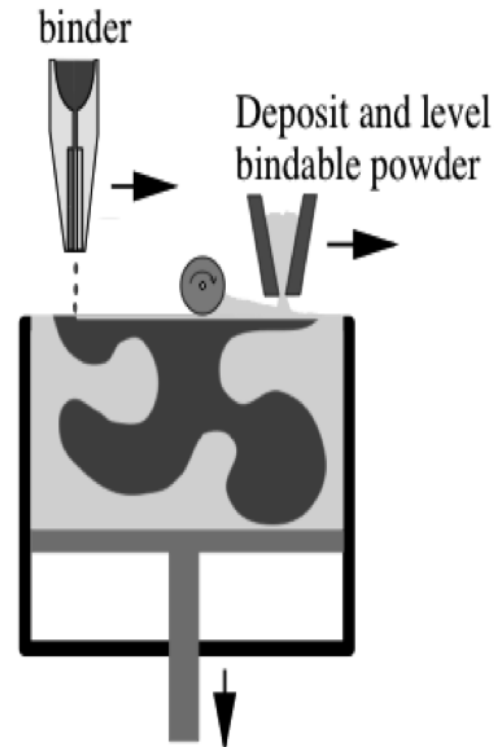

3DP

Sintering

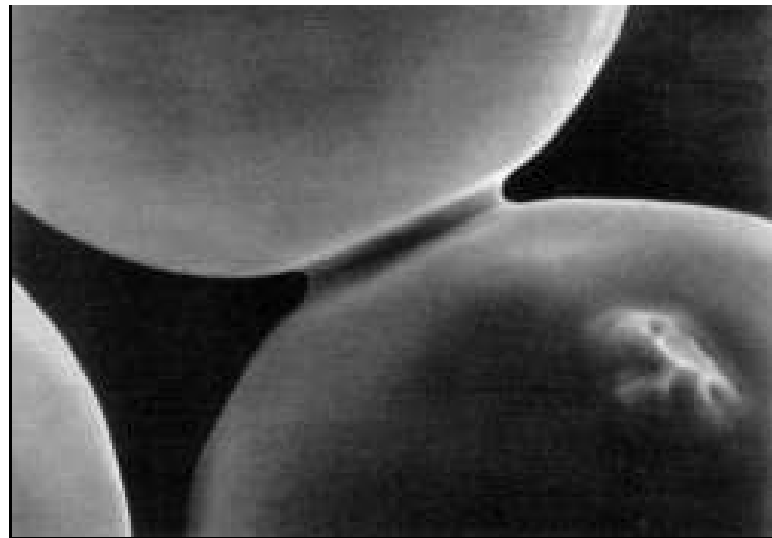
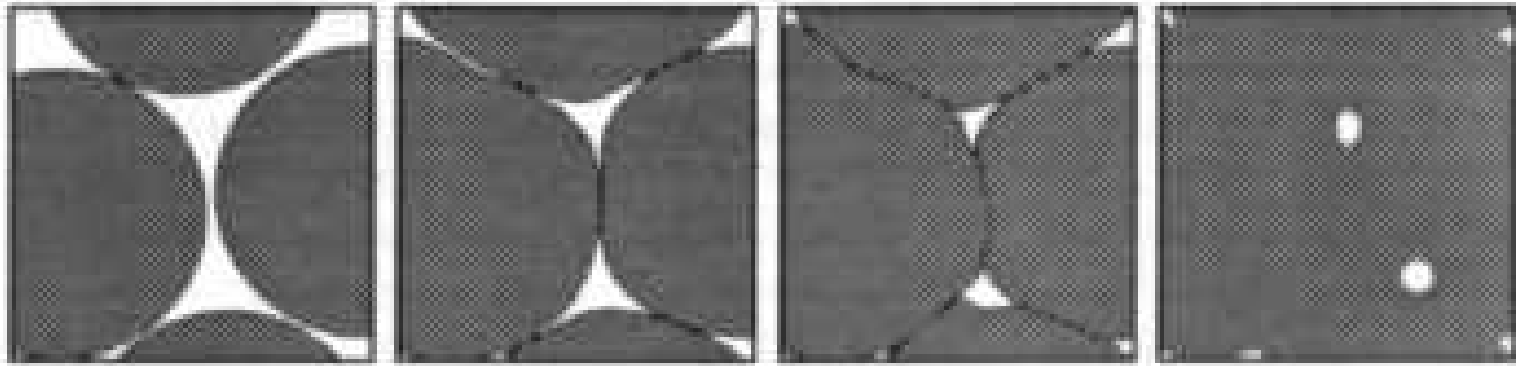

Sintering

- bonding of the metal, ceramic or plastic powders together when heated to temperatures in excess of approximately half the absolute melting temperature.
- In the industry, sintering is mainly used for metal and ceramic parts (Powder Metallurgy).
- After pressing (compaction) of the powder inside mold for deforming into high densities, while providing the shape and dimensional control, the compacted parts are then sintered for achieving bonding of the powders metallurgically.

Sintering in rapid prototyping

- Sintering process used in Rapid Prototyping differs from the Powder Metallurgy, such as:
 - Plastic based powders, in addition to metal powders.
 - Local sintering, not overall sintering.
 - Very short sintering period.
- Laser (heat source) is exposed to sections to be sintered for a very short time. Hard to achieve an ideal sintering.
- In some applications, for achieving the ideal sintering, the finished parts are heated in a separate sintering oven.

Laser sintering

- <https://www.youtube.com/watch?v=bgQvqVq-SQU>



Laser sintering



Laser sintering

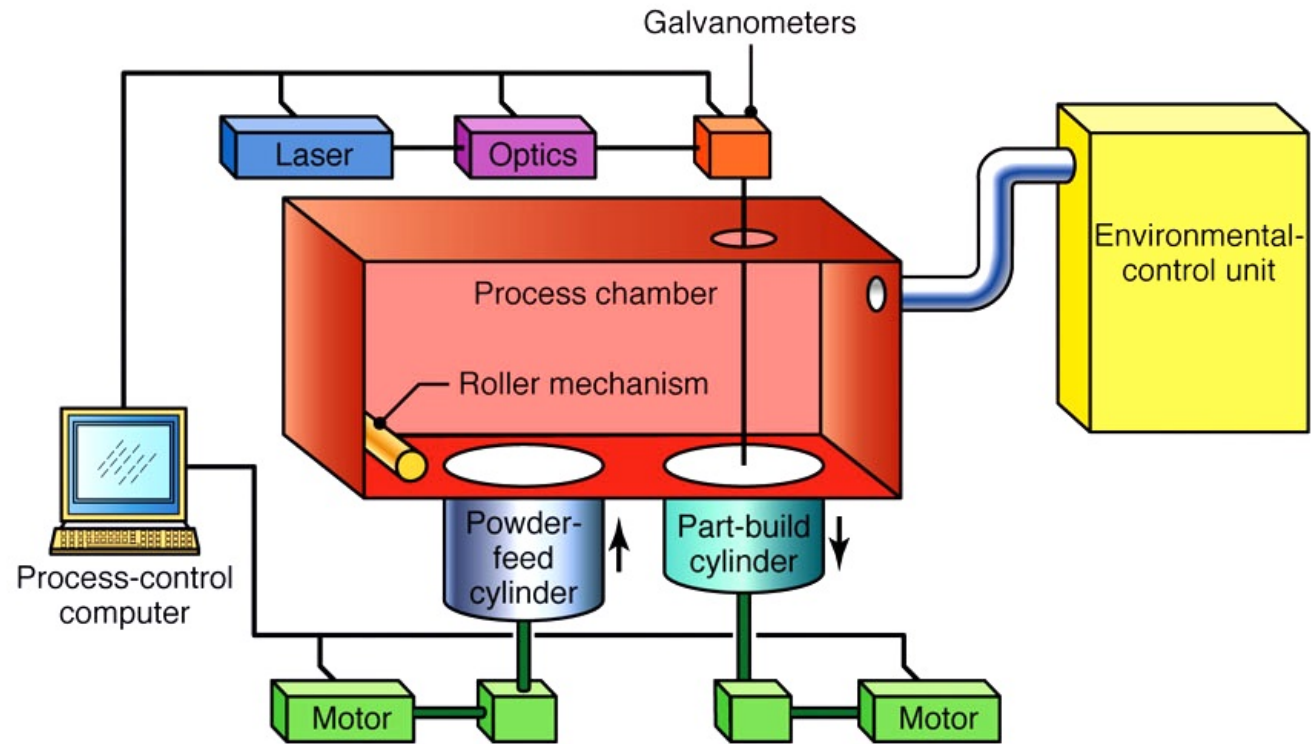

Laser sintering

- The fabrication chamber is maintained at a temperature just below the melting point of the powder
- Heat from the laser need only elevate the temperature slightly to cause sintering. This greatly speeds up the process;
- No supports are required with this method since overhangs and undercuts are supported by the solid powder bed;
- Surface finishes and accuracy are not quite as good as with stereolithography, but material properties can be quite close to those of the intrinsic materials

Laser sintering: materials

- Polymers
 - nylon, ABS, PVC, and polystyrene,
 - nylon/polycarbonate powders are health hazards (dangerous to breathe).
 - glass-filled or with other fillers
 - metals encapsulated in plastic.
- Metals
 - low melting metal alloys of nickel bronze, steel, titanium, alloy mixtures, and composites
- Green sand (for sand casting).

Laser sintering

- For direct production of tooling, including for plastic injection molding, metal die casting, sheet metal forming as well as metal parts, directly from steel based and other metal powders.

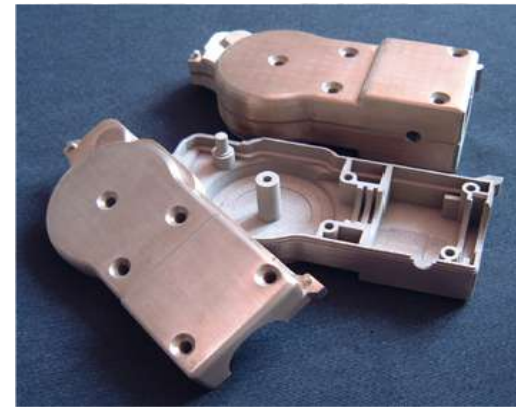

Laser sintering

- Advantages:
 - Cheap and no harmed healthy material,
 - Large selection of used materials,
 - no support construction,
 - Decreasing of destruction possibility of inside stresses.
- Disadvantages:
 - Roughness surface after final modification it means „stairs“ effect,
 - Porosity of components,
 - Different intensity in various parts of generated components,
 - Material transformations are needing cleaning of the production device

Laser engineered net shaping (LENS)

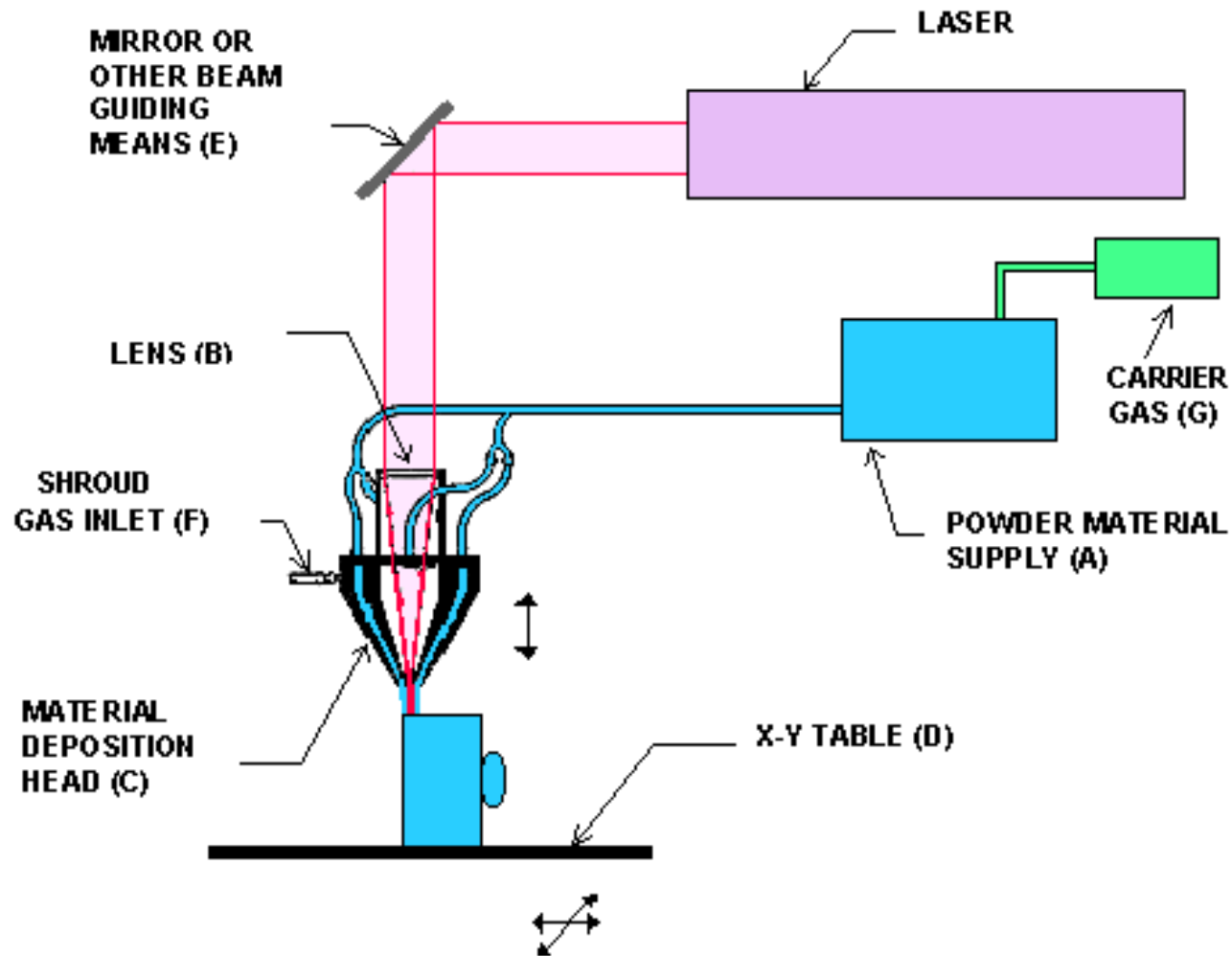

Fig. 8. Laser engineered net shaping.

Laser engineering net shaping (LENS)

- Fully Dense Metal parts with good metallurgical properties
- Laser melts metal powder
- Powder delivered coaxially with laser
- Inert gas protects weld pool
- Near net shape with some finish machining

Laser engineering net shaping (LENS)

- In addition to titanium, a variety of materials can be used such as stainless steel, copper, aluminum etc.
- Materials composition can be changed dynamically and continuously, leading to objects with properties that might be mutually exclusive using classical fabrication methods.
- Has the ability to fabricate fully-dense metal parts with good metallurgical properties at reasonable speeds;
- Objects fabricated are near net shape, but generally will require finish machining.

Laser engineering net shaping (LENS)

- <https://www.youtube.com/watch?v=d2foaRi4nxM>

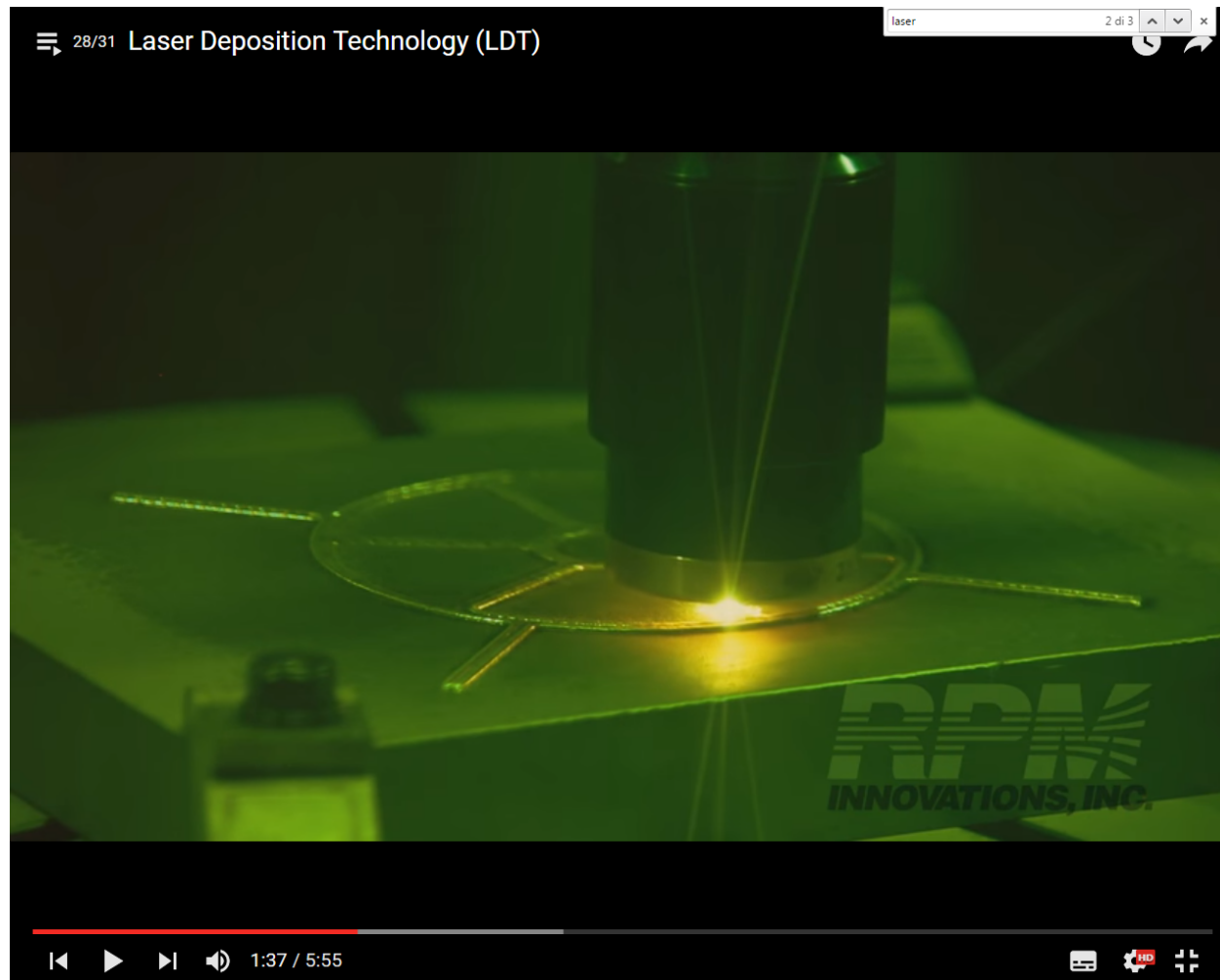

Fused Deposition Modelling (FDM)

- FDM is the second most widely used rapid prototyping technology, after stereolithography.
- A plastic filament is unwound from a coil and supplies material to an extrusion nozzle. The nozzle is heated to melt the plastic and has a mechanism which allows the flow of the melted plastic to be turned on and off.
- The nozzle is mounted to a mechanical stage which can be moved in both horizontal and vertical directions.
- As the nozzle is moved over the table in the required geometry, it deposits a thin bead of extruded plastic to form each layer.
- The plastic hardens immediately after being squirted from the nozzle and bonds to the layer below. The entire system is contained within a chamber which is held at a temperature just below the melting point of the plastic.

Fused Deposition Modelling

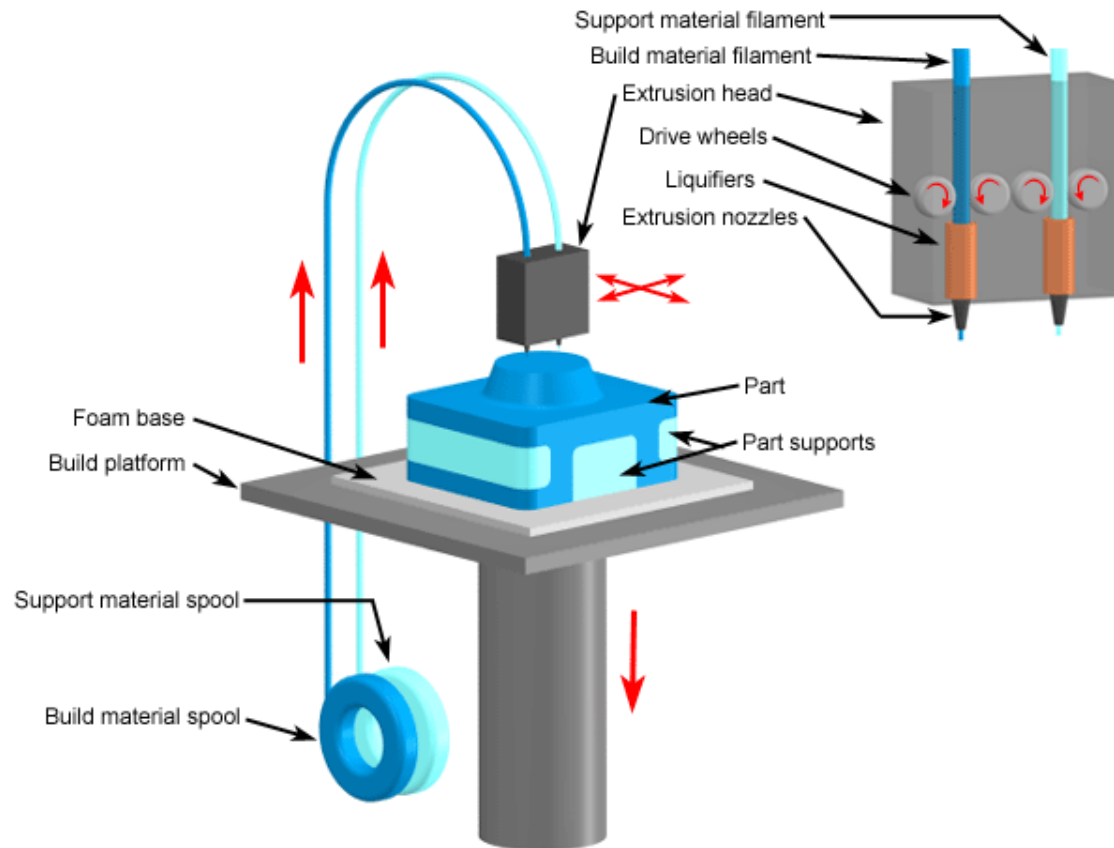

Fused Deposition Modelling

- <https://www.youtube.com/watch?v=WHO6G67GJbM>



Fused deposition modelling

- “Standard” materials:
 - Poly-Lactic-Acid (PLA) (soft and hard)
 - Acrylonitril-Butadiene-Stiren (ABS)
- “Experimental” materials:
 - Nylon
 - Polycarbonate (PC)
 - Poly vinyl alcohol (PVA)
 - Conductive (carbon and graphene loaded materials)
 - Metallic loaded plastics

Rapid tooling

- Indirect rapid prototyping
 - Molds fabricated with RP devices (CAD/CAM)
 - Casting of the desired (bio-)material
 - Extraction of the final object

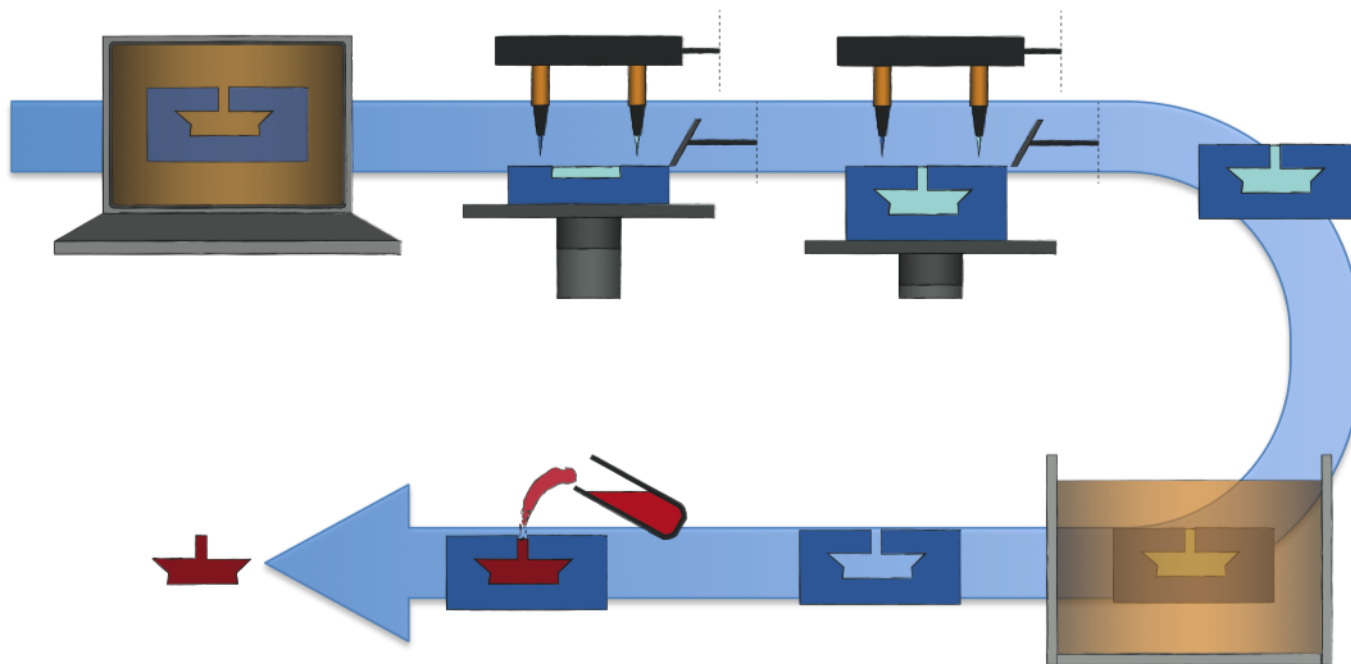

- Comparative analysis

Additive manufacturing

- Features of AM Systems:
 - Process type - Stereo lithography, Laminating, Fused deposition modelling, Sintering of powder, Solid ground curing, etc.
 - Work space(mm) - depends on the models
 - Material - photopolymer resin, coated paper, ABS, wax, metal alloy, etc.

Which Process Should You Pick?

- Do you need a prototype (not just a model)?
 - SLS, FDM (for robustness, strength).
- Do you need a mold for a small batch?
 - SLA (for smooth, hard surface).
- Does part need multiple colors?
 - 3D Color-Printing.
- Does part have convoluted internal spaces?
 - 3D-Print, SLS, SLA (easy support removal).

NOT ACCURATE
NOT REPEATABLE



VERY REPEATABLE
NOT ACCURATE



VERY ACCURATE
VERY REPEATABLE



ACCURACY

Degree of conformity of a measurement to a standard or known value

REPEATABILITY

The closeness of agreement among a number of consecutive measurements

RESOLUTION

The smallest degree of movement that a scale can detect

Accuracy, resolution and surface finishing

	Layer thickness(mm)	Accuracy (mm)
SLA	0.05 - 0.3	0.01 - 0.2
LOM	0.1 - 1	0.1 - 0.2
FDM	≈0.05	0.130 - 0.260
SLS	≈0.08	0.03 - 0.4
SGC	0.01 - 0.15	0.05 - 0.5

Accuracy, resolution and surface finishing

- Accuracy and resolution
 - tolerances are still not quite at the level of CNC, because of intervening energy exchanges and/or complex chemistry one cannot say with any certainty that one method of RP is always more accurate than another, or that a particular method always produces a certain tolerance.

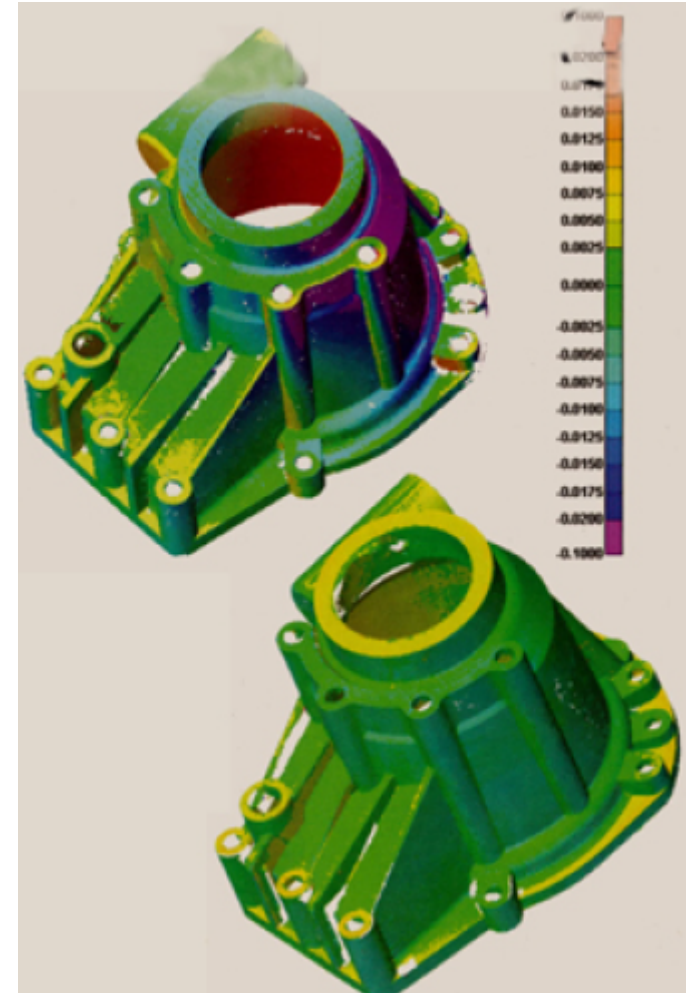

Accuracy, resolution and surface finishing

- Stair Stepping:
 - Since rapid prototyping builds object in layers, there is inevitably a "stair stepping" effect produced because the layers have a finite thickness.

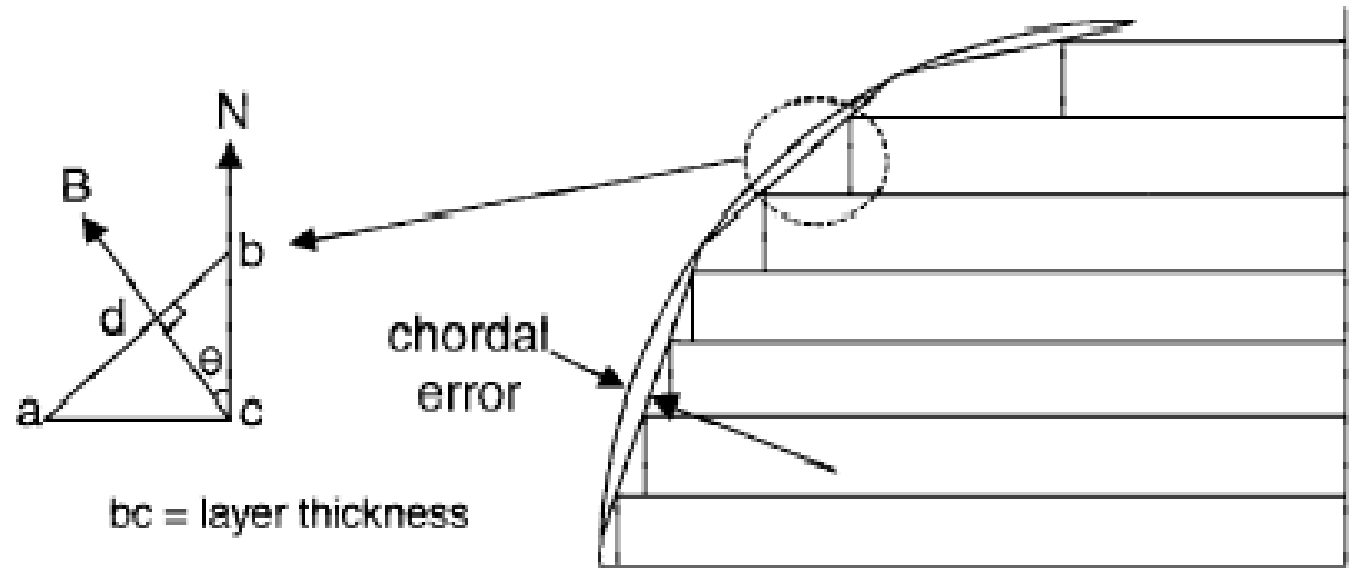

Accuracy, resolution and surface finishing

- FINISH
 - The finish and appearance of a part are related to accuracy, but also depend on the method of RP employed.
 - Technologies based on powders have a sandy or diffuse appearance, sheet-based methods might be considered poorer in finish because the stairstepping is more pronounced.

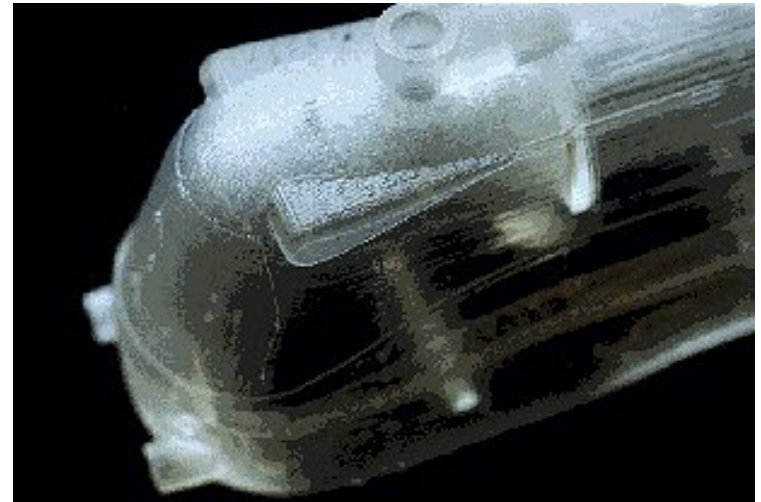

Accuracy, resolution and surface finishing

Technology	SLA	SLS	FDM	Wax Inkjet	3D printer	LOM
Max Part Size (cm)	30x30x50	34x34x60	30x30x50	30x15x21	30x30x40	65x55x40
Speed	Average	Average to fair	Poor	Poor	Excellent	Good
Accuracy	Very good	Good	Fair	Excellent	Fair	Fair
Surface finish	Very good	Fair	Fair	Excellent	Fair	Fair to poor
Strenghts	Market leader, large part size, accuragy, wide product	Market leader, accuracy, materials, large part size	Lab on desktop, price, materials	Accuracy, finish, lab on desktop	Speed, lab on desktop, price, color	Large part size, good for large castings, material cost
Weaknesse s	Post processing messy liquids	Size and weight, system price, surface finish	Speed	Speed limited, materials, part size	Limited materials, fragile parts, finsh	Part stability, smoke, finish and accuracy

Cost

Machine	Cost	Material	Application
Fused Deposition Modeler 1600 (FDM)	\$10/hr	ABS or Casting Wax	Strong Parts Casting Patterns
Laminated Object Manufacturing (LOM)	\$18/hr	Paper (wood-like)	Larger Parts Concept Models
Sanders Model Maker 2 (Jet)	\$3.30/hr	Wax	Casting Pattern
Selective Laser Sintering 2000 (SLS)	\$44/hr	Polycarbonate TrueForm SandForm	light: 100%; margin: 0">Casting Patterns Concept Models
Stereolithography 250 (SLA)	\$33/hr	Epoxy Resin (Translucent)	Thin walls Durable Models
Z402 3-D Modeller (Jet)	\$27.50/hr	Starch/Wax	Concept Models

Cost

- System costs
 - from \$30,000 to \$800,000
 - training, housing and maintenance (a laser for a stereolithography system costs more than \$20,000)
- Material
 - High cost
 - Available choices are limited.

Cost - vendors

Photopolymer

3D System (formerly DTM)	US	http://www.3dsystems.com
EOS	Germany	http://www.eos.info/en
CMET	Japan	http://www.cmet.co.jp/eng/
Envisiontec Perfactory	Germany	http://www.envisiontec.de

Deposition

Stratasys	FDM	US	http://www.stratasys.com
SolidScape (now it is a Stratasys company)	Inkjet	US and the Netherlands	http://www.solid-scape.com
3D Systems (formerly DTM)	Thermojet™	US	http://www.3dsystems.com
Soligen	casting cores/patterns	US	http://www.soligen.com

Selective laser sintering

3D Systems	US	http://www.3dsystems.com
EOS	Germany	http://www.eos.info/en

Hidden cost - time

- Secondary Operations
 - Post Curing (Stereolithography)
 - Infiltration, for fragile parts (3DP, MJM, SLS)
 - Final machining of metal parts
 - Removing of the support structures

Support structure (red material),
water-soluble, fused deposition
modeling



Support structure,
stereolithography.

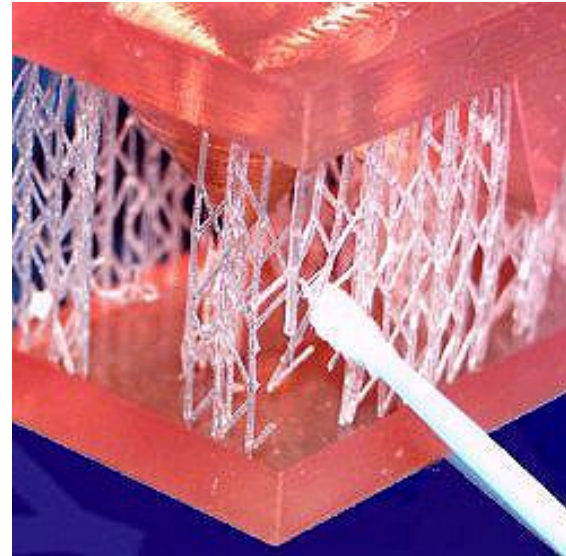

Asking for a quote

<https://www.stratasysdirect.com/>



<https://www.3dhubs.com/>

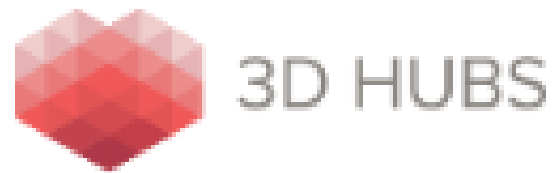









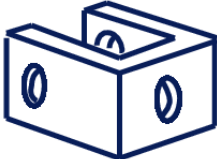

Question

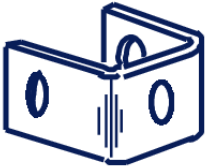
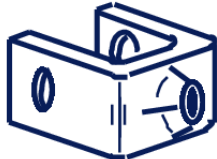
- Is it a good choice to 3D print every object?

Design for manufacturing

A simple fork end for Pneumatic Piston

					
Machine from Solid	Welded Assembly	Casting	Extrusion or Stock Channel	Sheet Metal	Injection Mold
	 x3				
\$95	\$75	\$55	\$25	\$1.20	\$0.30
Piece-part costs					
\$10	\$100	\$400	\$8	\$5,000	\$60,000
Tooling costs					

Production Volume: Recurring Costs versus Non-Recurring Costs

Software for Additive Manufacturing

AM work-flow

- Solid Modelling
- Tessellation/Generation of STL file
- Support Generation
- “Slicing” of the Model
- Model Physical Buildup
- Cleanup and Post Curing
- Surface Finishing

AM work-flow

File



Description



Software

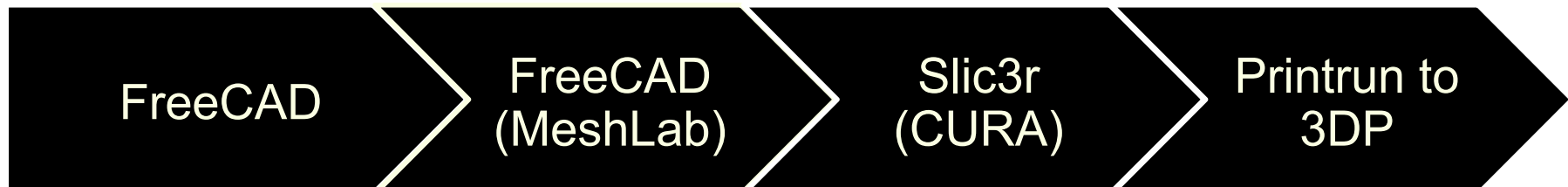

Data Source

Data source

- Representation of a volume
 - CAD model
 - Your specific design
 - Web repository
- Instruments output
 - Segmentation of medical Images (Tomographic Data: CT scan, RM scan)
 - Surface scanning
 - Laser
 - Optical (also phone camera)

CAD model

Dimensions of CAD Elements	Elements	Type of CAD Model
0D	Point	Corner Model
1D	Line	Edge Model
2D	Surface	Surface Model
3D	Solid/Volume	Solid or Volume Model

- Most of the CAD software are proprietary with a relatively high cost
- Free or Open Source examples
 - FreeCAD
 - 123D Design
 - Sketch Up

CAD model

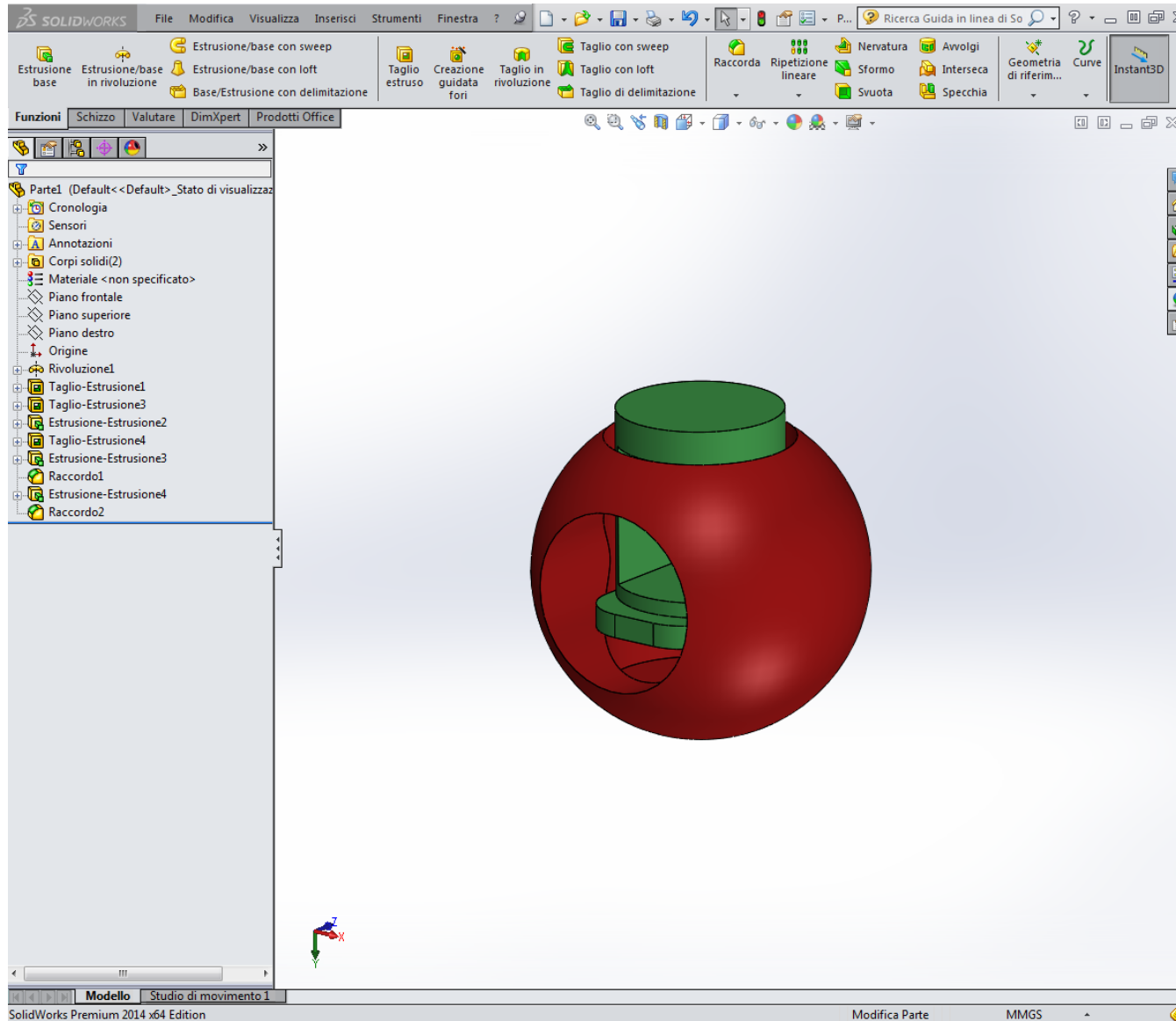

Segmentation

- Segmentation subdivides an image into its constituent regions or objects.
- The level to which the subdivision is carried out depends on the problem being solved

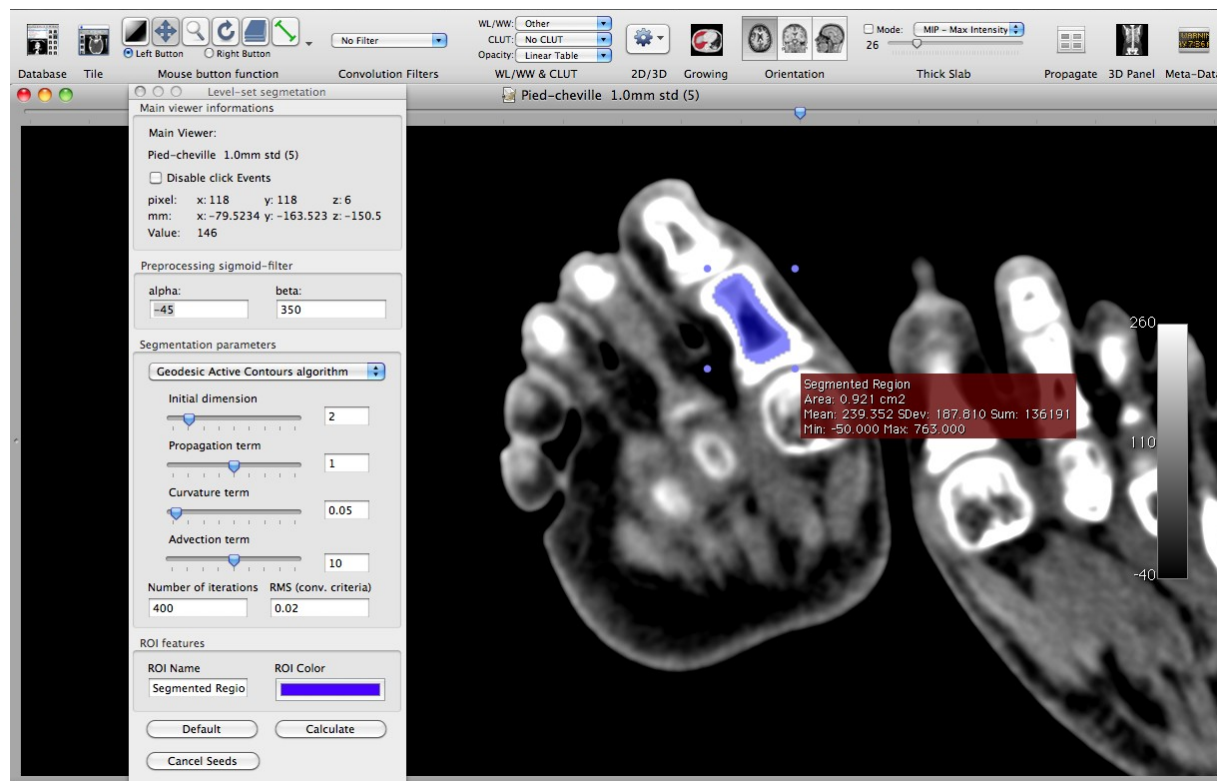

Bioimaging software

- OsiriX (www.osirix-viewer.com)
- 3DSlicer (www.slicer.org)
- ImageJ (rsb.info.nih.gov/ij)
- MIPAV (mipav.cit.nih.gov)
- itk-SNAP (www.itksnap.org)

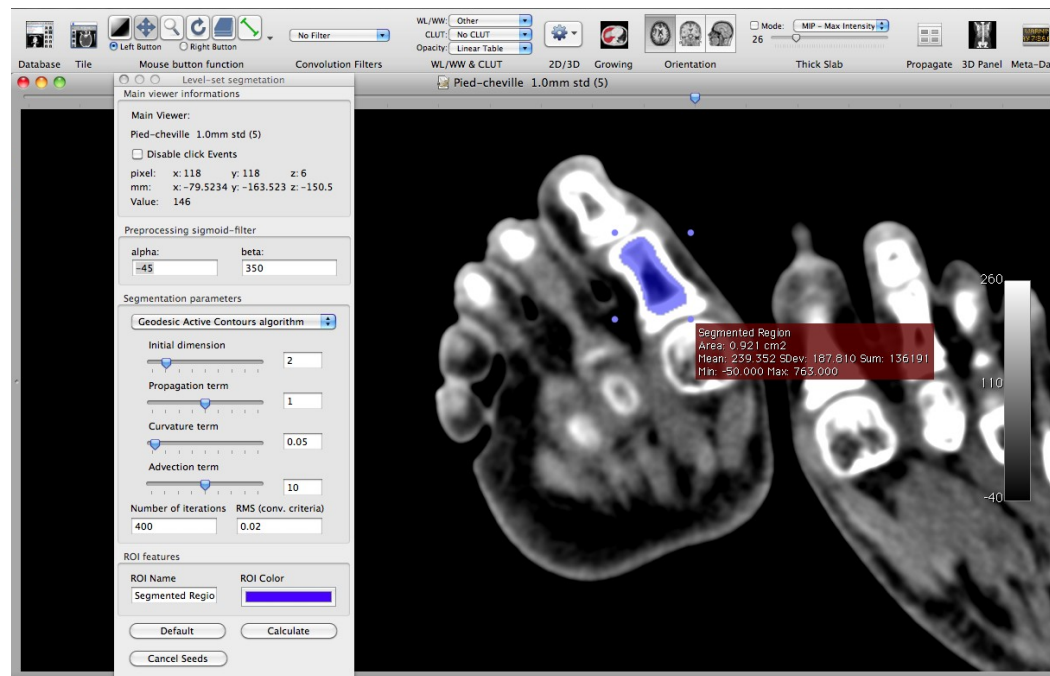

From 3D scan to 3D model

- Use of 123DCatch
- <http://www.123dapp.com/catch>
- 3D model of a fossil
 - Ammonite from Museum of Natural History in Pisa

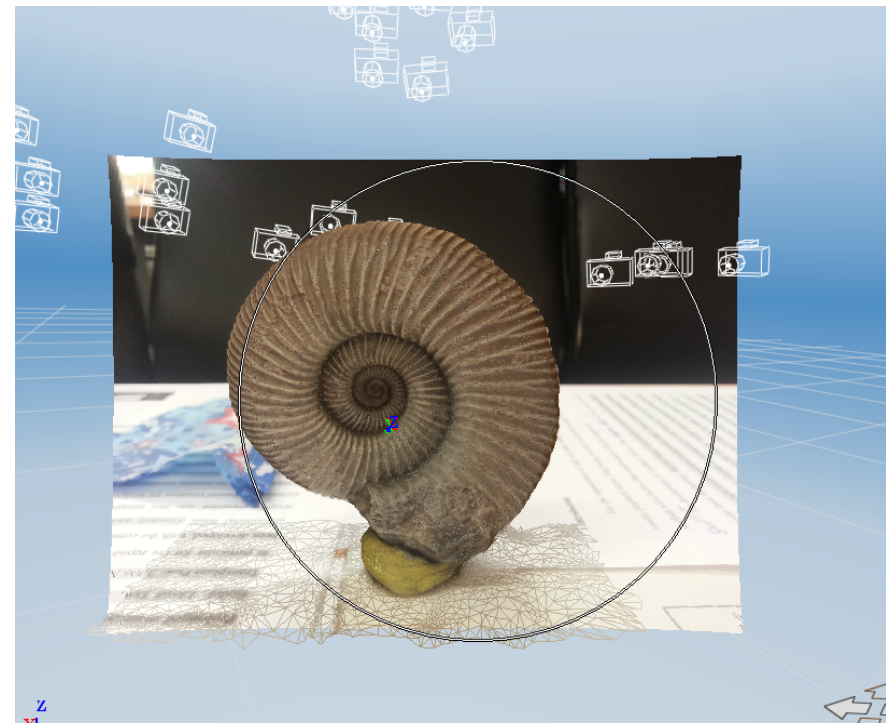

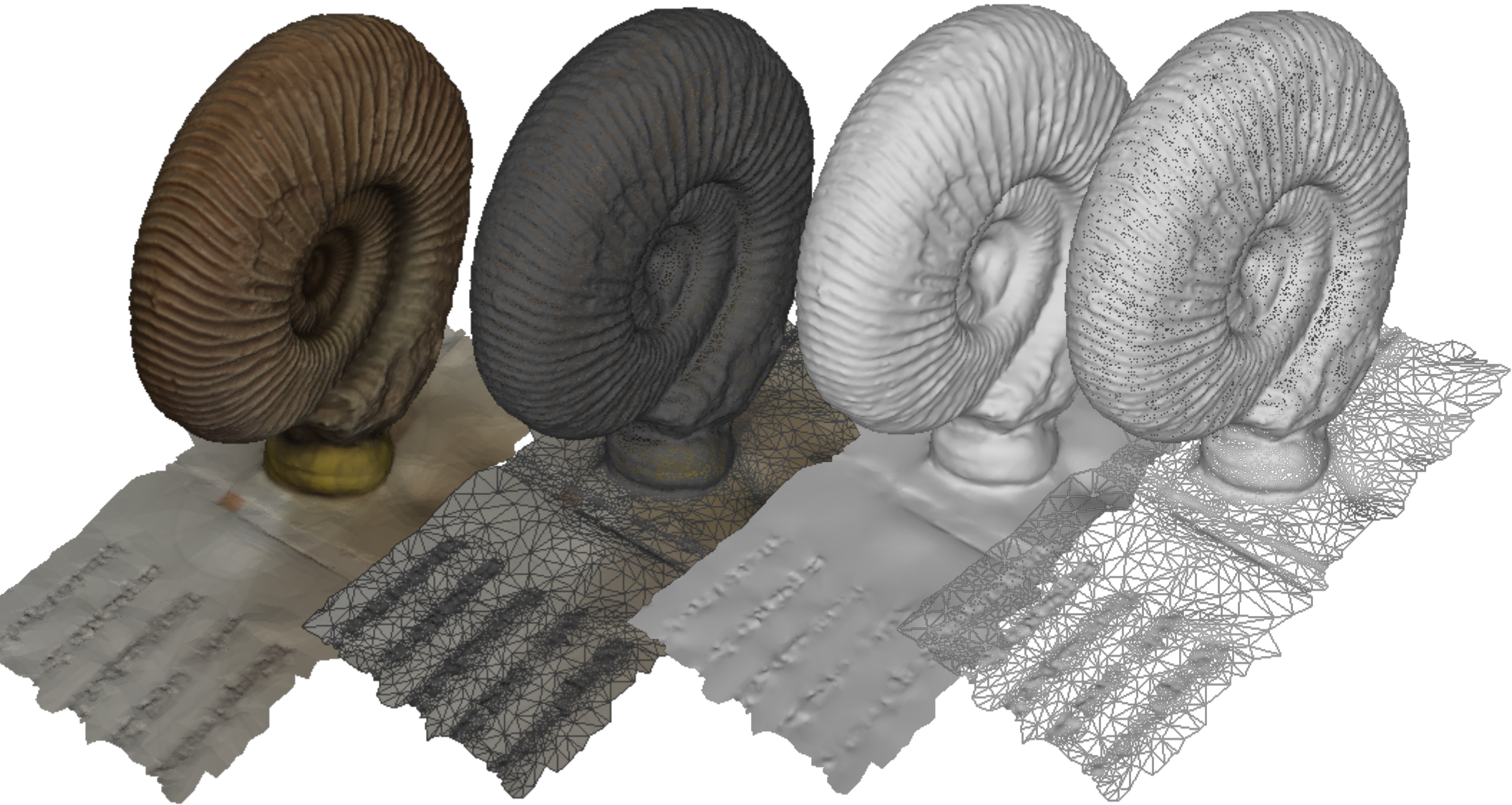



Exchange formats

STL file (*.stl)

- STL files describe only the surface geometry of a three dimensional object without any representation of color, texture or other common CAD model attributes.
- An STL file describes a raw unstructured triangulated surface by the unit normal and vertices (ordered by the right-hand rule) of the triangles using a three-dimensional Cartesian coordinate system.

Example of *.stl representation

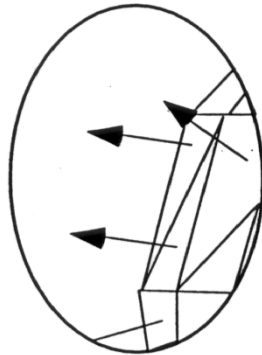
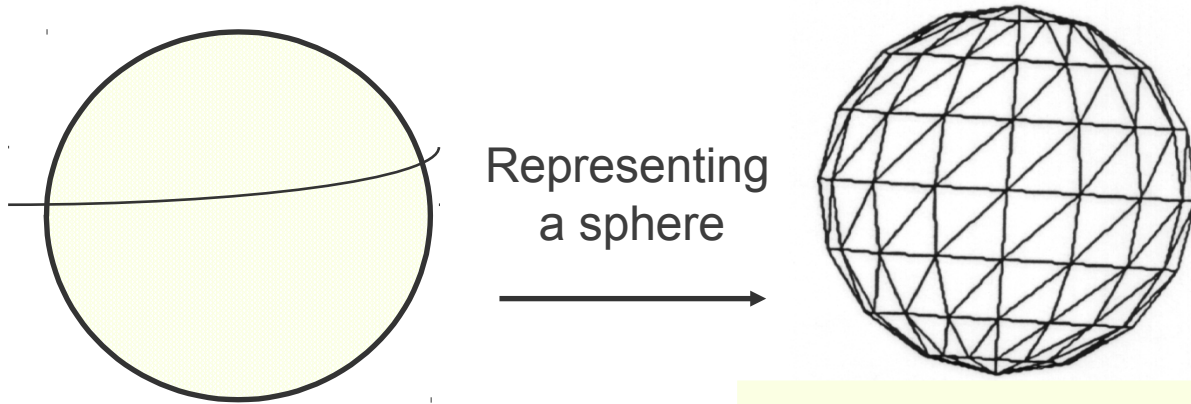

```
solid obj1
facet normal 1.457591e-01 -9.885599e-01 -3.877669e-02
  outer loop
    vertex 9.614203e+00 4.757629e+00 0.000000e+00
    vertex 7.875000e+00 4.501190e+00 0.000000e+00
    vertex 9.483117e+00 4.764183e+00 -6.598330e-01
  endloop
endfacet
facet normal 1.161178e-01 -9.870778e-01 -1.104267e-01
  outer loop
    vertex 9.483117e+00 4.764183e+00 -6.598330e-01
    vertex 7.875000e+00 4.501190e+00 0.000000e+00
    vertex 9.109818e+00 4.782848e+00 -1.219212e+00
  endloop
endfacet
facet normal 6.134766e-02 -9.843393e-01 -1.652652e-01
```

Example of *.stl representation

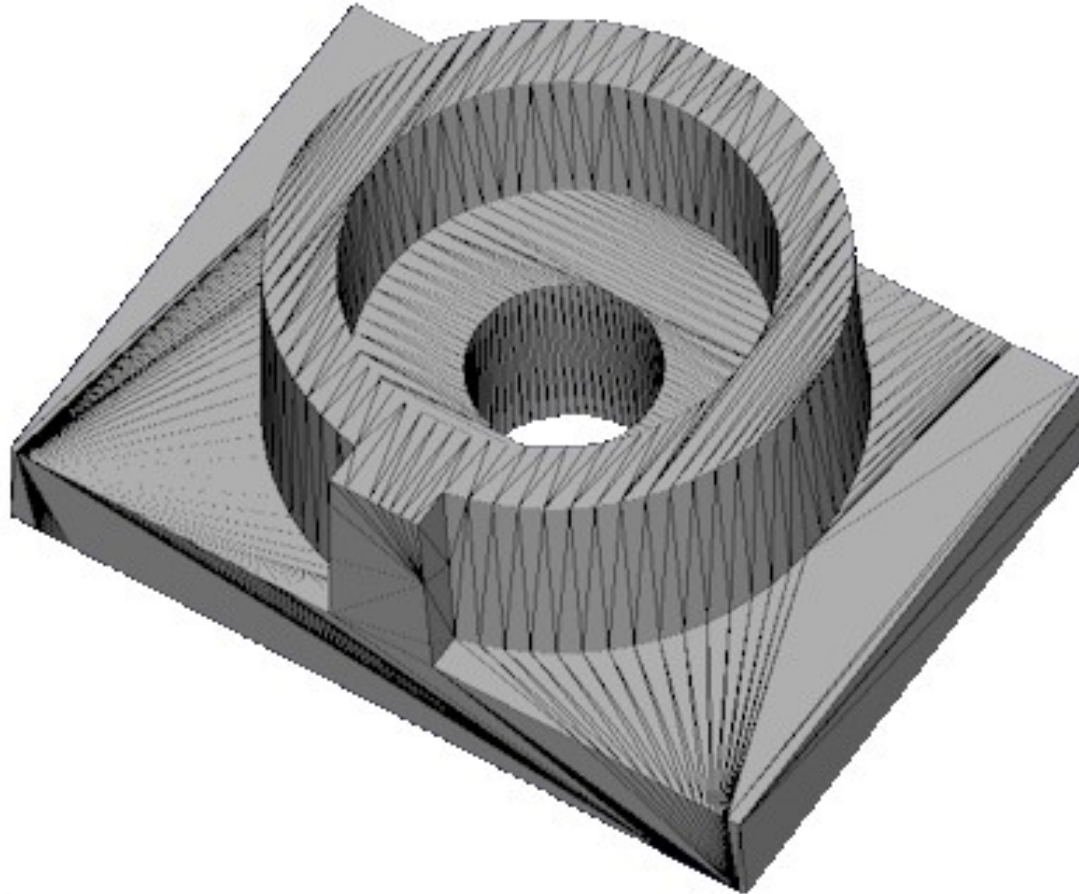

STL file

Advantages	Disadvantages
Simple	Geometry leaks
Sequential memory access*	No specified units
Portable	Unnecessary redundancy
	Incompatible with color, multiple materials, etc
	Poor scalability
*Does not require large amounts of RAM, critical in '80s	Lacks auxiliary information

- There are several other formats
 - 3D PDF, ISO 14649 (STEP-NC), STEP / IGES, SAT, Parasolid, X3D VRML, PLY, 3DS, SLC

Additive manufacturing format (AMF)

- XML format
 - metadata
- Compressibility
 - Curved mesh
- Encryption and watermark
- Multiple material
 - Graded Material
 - Internal microstructures
- Appearance
 - Color
 - Tolerance
 - Texture



AMF – ISO standard

The image shows a screenshot of the ISO Store website. At the top, there is a navigation bar with the ISO logo on the left and links for 'Standards', 'About us', 'Standards Development', 'News', and 'Store'. A search bar is located on the right side of the navigation bar. Below the navigation bar, there is a breadcrumb trail: 'ISO Store > Store > Standards catalogue > By TC > ISO/TC 261 Additive manufacturing'. The main heading is 'ISO/ASTM 52915:2013' with a small orange icon to the right. Below the heading is the subtitle 'Standard specification for additive manufacturing file format (AMF) Version 1.1'. There is an 'Abstract' section on the left and a 'Preview ISO/ASTM 52915:2013' button. The abstract text describes the framework for an interchange format for additive manufacturing technology. On the right side, there is a product selection panel with 'FORMAT' and 'LANGUAGE' options. The 'FORMAT' section has two options: 'PDF' (selected) and 'PAPER'. The 'LANGUAGE' section has two options: 'English' (selected). Below the format and language options, the price is shown as 'CHF 88' and there is an 'Add to basket' button. At the bottom right, there is a 'Keep up to date with ISO' section with a 'Subscribe' button. At the bottom left, there is a 'General information' section with tabs for 'General information', 'Revisions', and 'Corrigenda / Amendments'. The 'General information' tab is active, showing the following details: 'Document published on: 2013-06-01', 'Edition: 1 (Monolingual)', 'ICS: 35.240.50; 25.040.20', 'Status: ✓ Published', 'Stage: 90.92 (2014-09-17)', 'TC/SC: ISO/TC 261', and 'Number of Pages: 15'. At the bottom of the page, there is a 'Got a question?' section with a link to 'Check out our FAQs' and a link to 'Email customer services'.

ISO Store > Store > Standards catalogue > By TC > ISO/TC 261 Additive manufacturing

ISO/ASTM 52915:2013

Standard specification for additive manufacturing file format (AMF) Version 1.1

Abstract

[Preview ISO/ASTM 52915:2013](#)

ISO/ASTM 52915:2013 describes a framework for an interchange format to address the current and future needs of additive manufacturing technology. For the last three decades, the STL file format has been the industry standard for transferring information between design programs and additive manufacturing equipment. An STL file contains information only about a surface mesh and has no provisions for representing color, texture, material, substructure, and other properties of the fabricated target object. As additive manufacturing technology is quickly evolving from producing primarily single-material, homogenous shapes to producing multimaterial geometries in full colour with functionally graded materials and microstructures, there is a growing need for a standard interchange file format that can support these features.

General information | [Revisions](#) | [Corrigenda / Amendments](#)

Document published on: 2013-06-01

Edition: 1 (Monolingual) **ICS:** 35.240.50; 25.040.20

Status: ✓ Published **Stage:** 90.92 (2014-09-17)

TC/SC: ISO/TC 261 **Number of Pages:** 15

FORMAT ? **LANGUAGE**

✓ PDF English ▾

PAPER English ▾

CHF 88 [Add to basket](#)

Keep up to date with ISO
Sign up to our newsletter for the latest news, views and product information

[Subscribe](#)

Got a question?
[Check out our FAQs](#)

[Email customer services](#)

3MF format

- <http://3mf.io/>

3MF design considerations

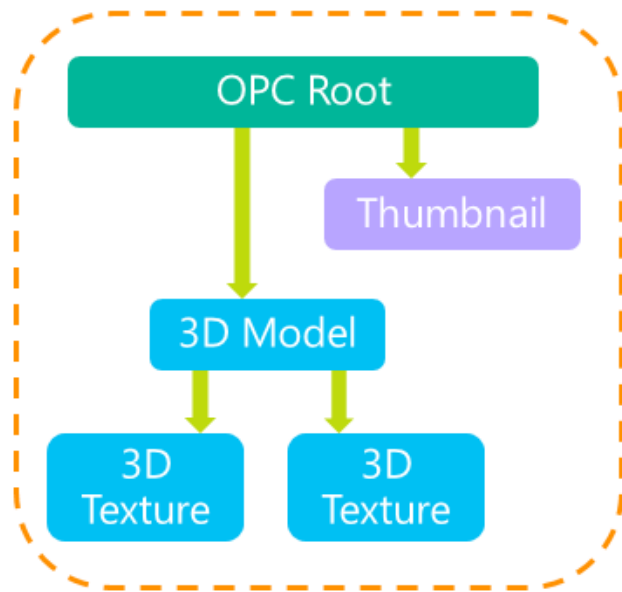

Complete

- Open Packaging Conventions (OPC)

Compact

- ZIP package
- References avoid duplication

Human-readable

- XML
- Well-known binary formats (e.g. PNG, JPEG)



MeshLab

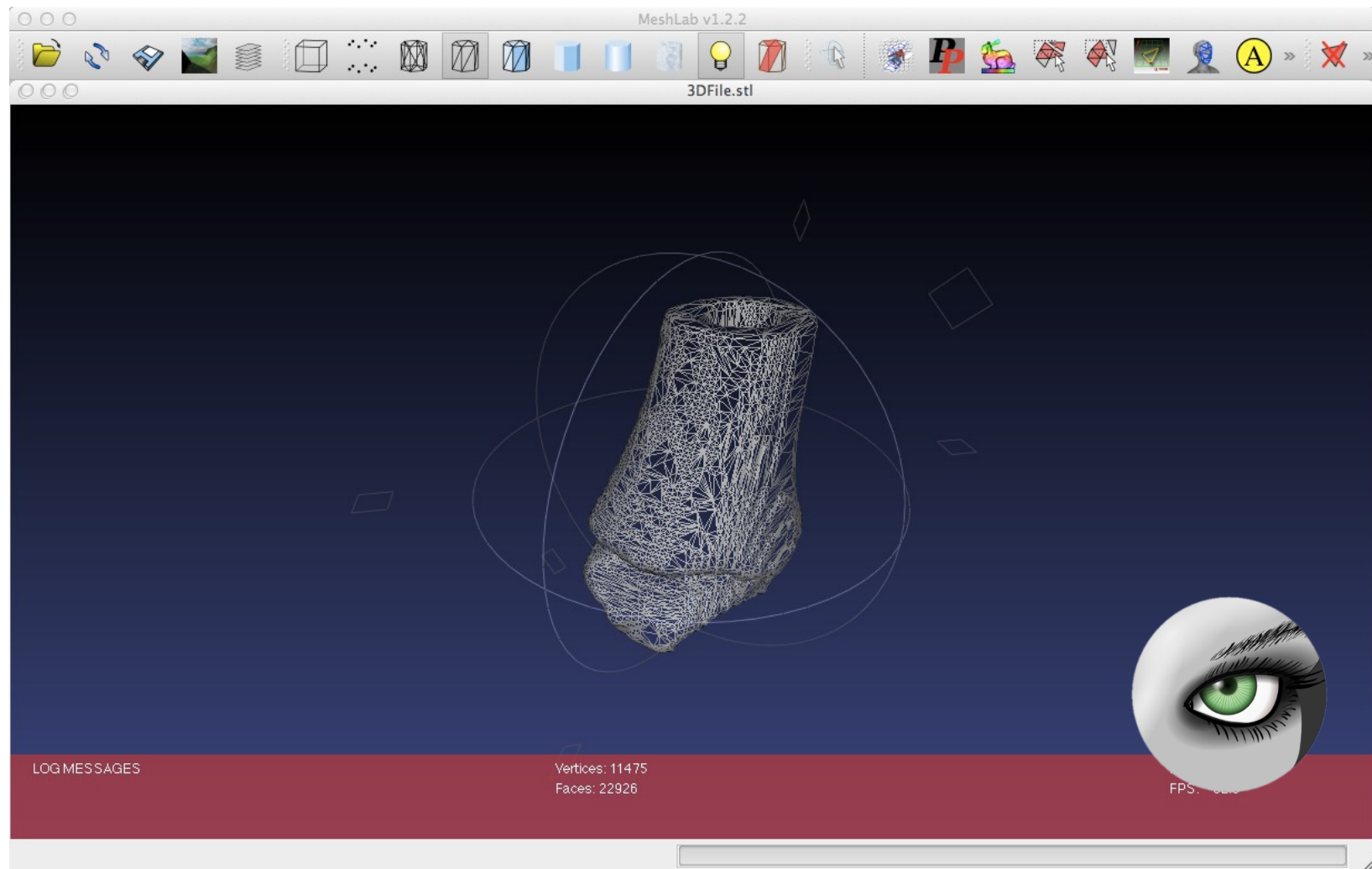

Netfabb

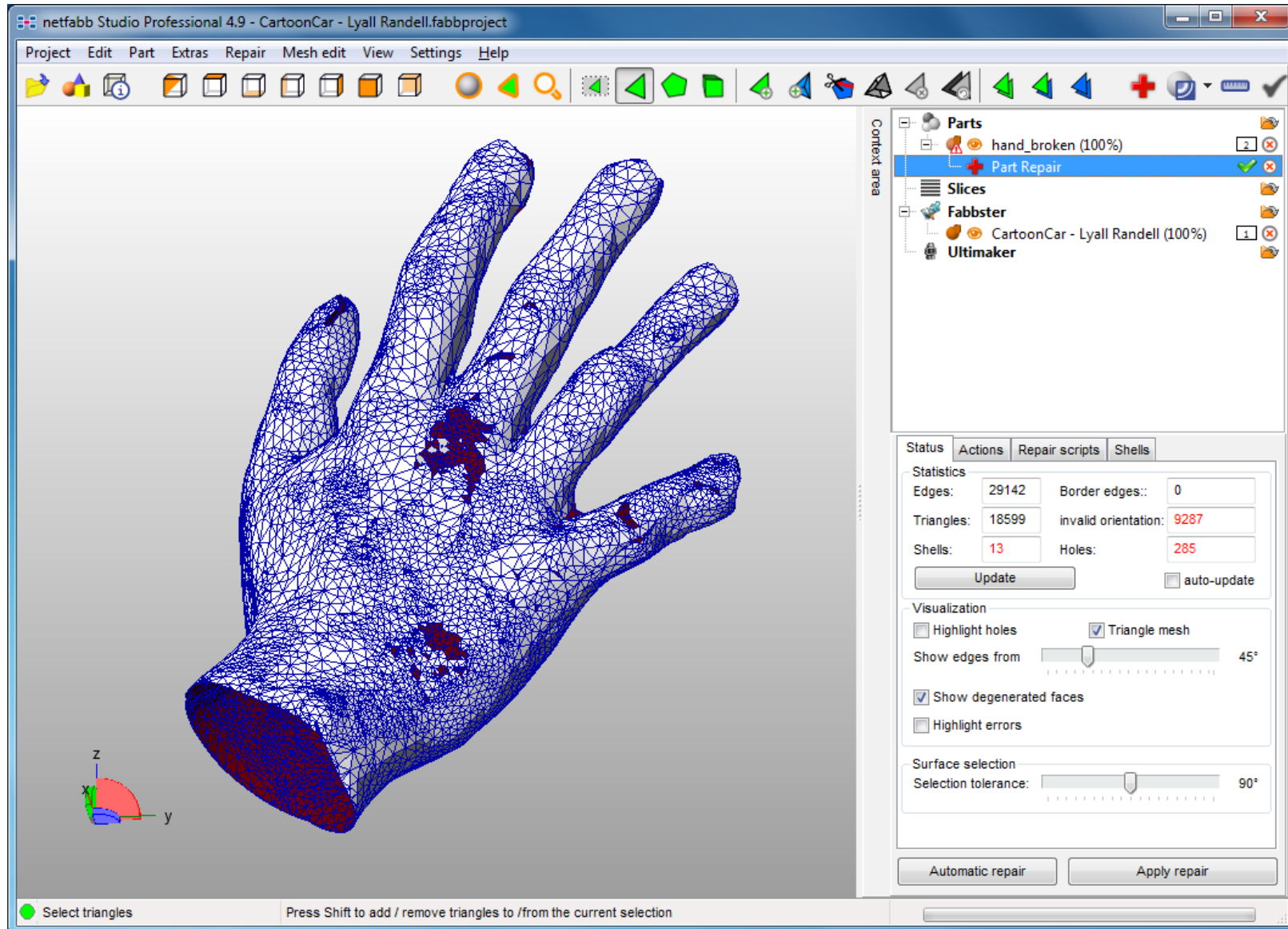

MeshMixer

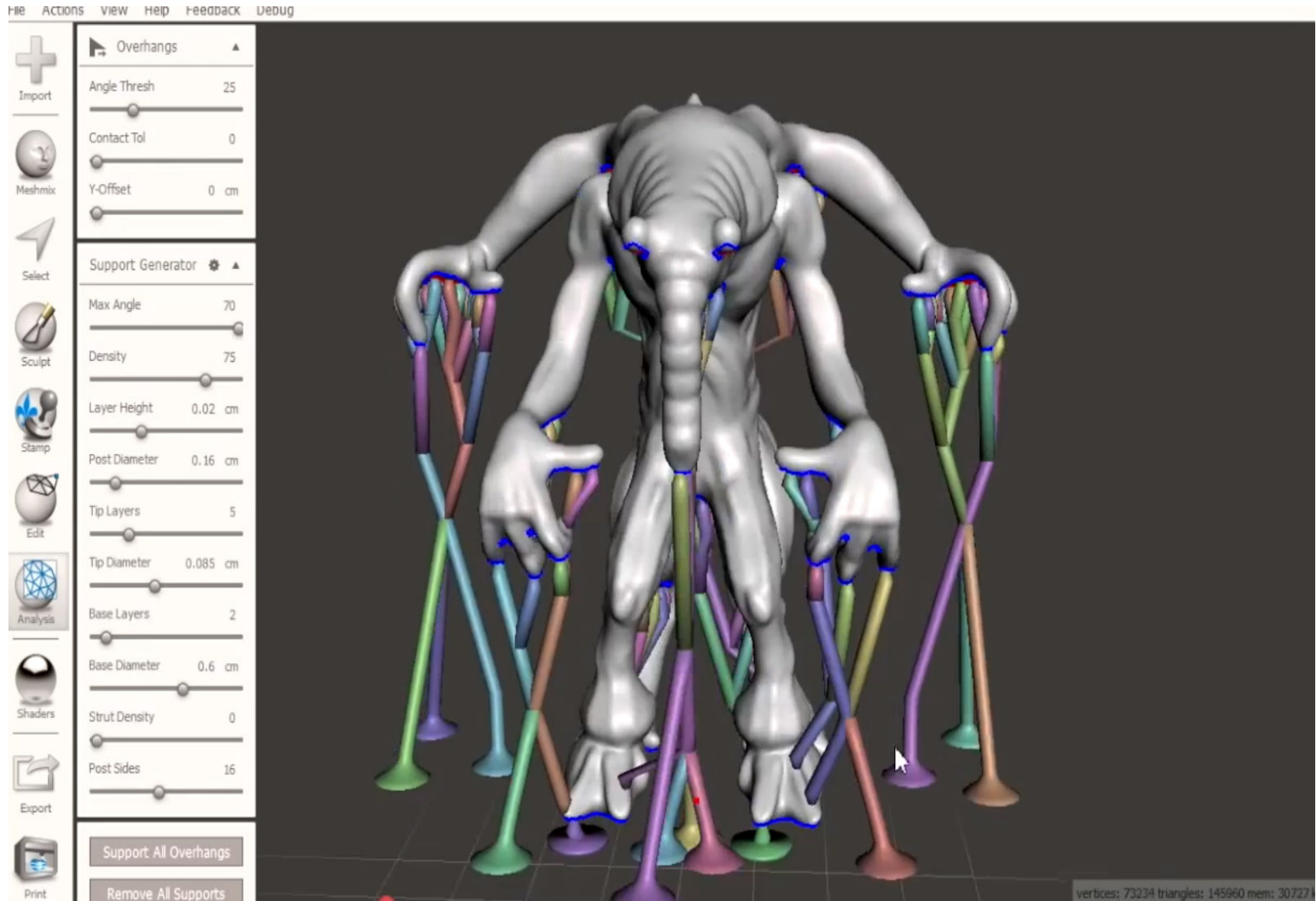

From CAD to CAM

Processing of *.stl files

- After the CAD system has generated *.stl file, it can be passed to the AM machine
- Machine then processes the *.stl file, slicing it into many thin layers stacked on one another. The resulting files are called slice files.
- The shapes of the slices represent cross sections
- In AM processes thick solid sections of material are often removed and replaced with cross hatching
- Thus AM parts are usually hollow, with cross hatching on the inside to add strength/stability

Support material

- Some AM techniques use two materials in the course of constructing parts.
- The first material is the part material and the second is the support material (to support overhanging features during construction).
- The support material is later removed by heat or dissolved away with a solvent or water.

Support material

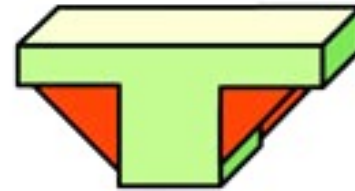
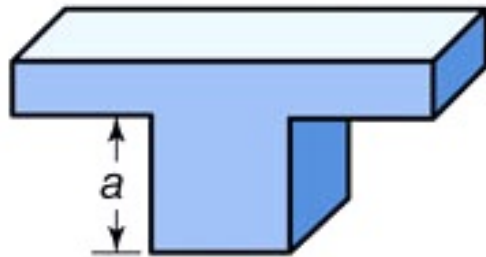

Gussets



Island

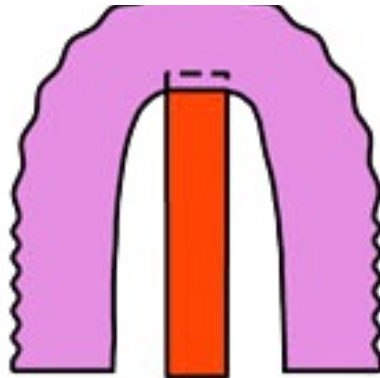

Ceiling within an arch

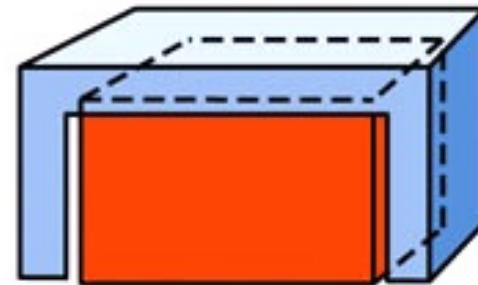

Ceiling

Patterning



Vector

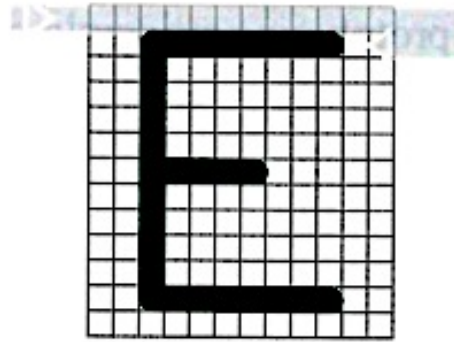

Raster

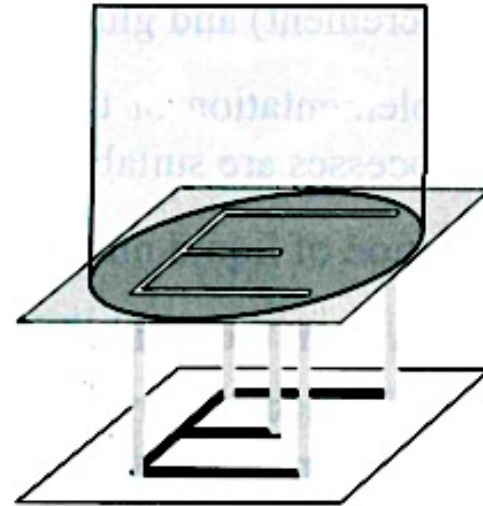

Projection

G-code

- Originally called “Word Address” programming format.
- Processed one line at a time sequentially.

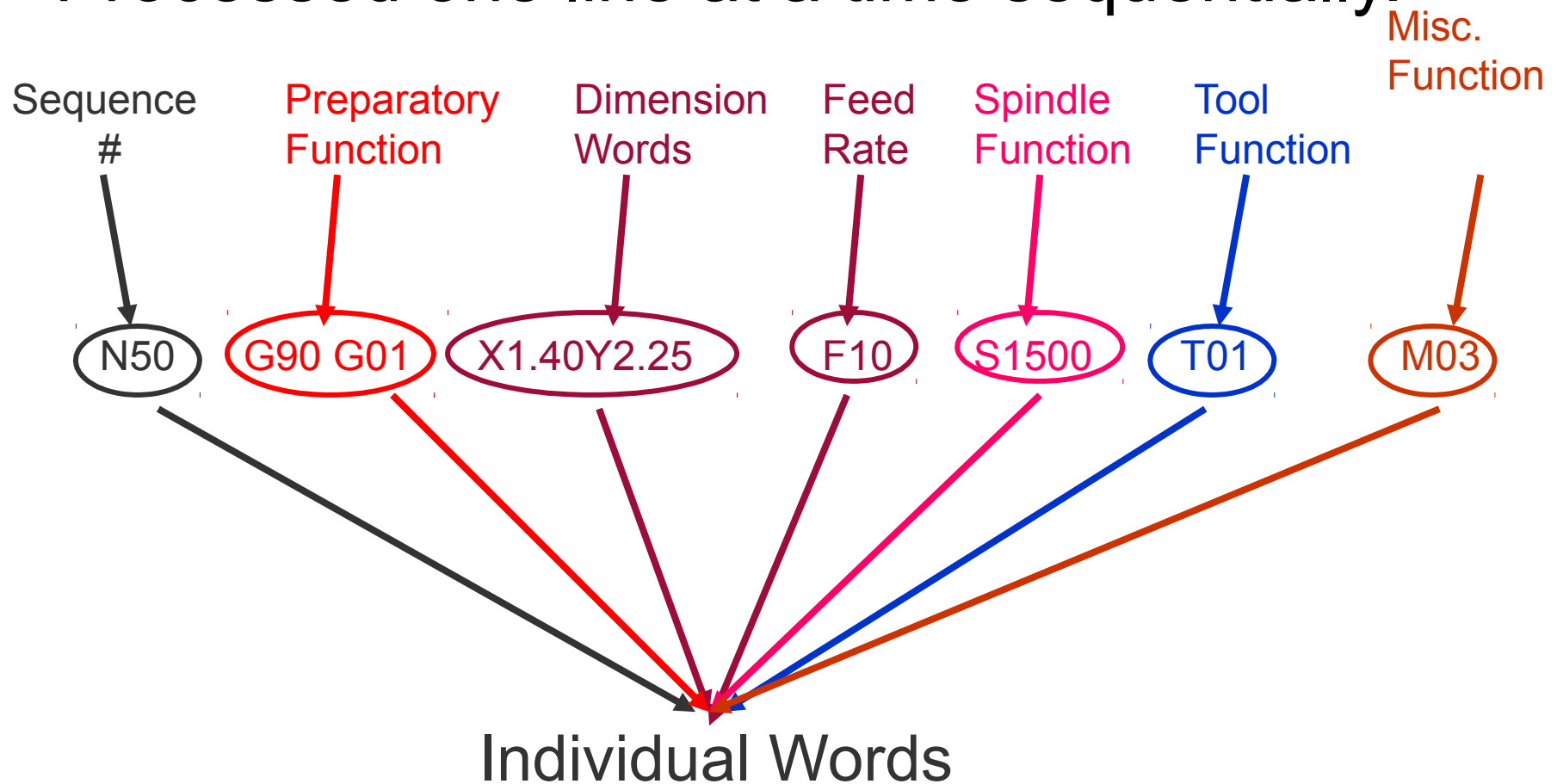

G-code example

- ;Generated with Cura_SteamEngine 13.11.2
- M109 T0 S227.000000
- T0
- ;Sliced ?filename? at: Tue 26-11-2013 17:33:05
- ;Basic settings: Layer height: 0.2 Walls: 0.8 Fill: 20
- ;Print time: #P_TIME#
- ;Filament used: #F_AMNT#m #F_WGHT#g
- ;Filament cost: #F_COST#
- G21 ;metric values
- G90 ;absolute positioning
- M107 ;start with the fan off
- G28 X0 Y0 ;move X/Y to min endstops
- G28 Z0 ;move Z to min endstops
- G1 Z15.0 F?max_z_speed? ;move the platform down 15mm
- G92 E0 ;zero the extruded length
- G1 F200 E3 ;extrude 3mm of feed stock
- G92 E0 ;zero the extruded length again
- G1 F9000
- M117 Printing...
- ;Layer count: 179
- ;LAYER:0
- M107
- G0 F3600 X87.90 Y78.23 Z0.30
- ;TYPE:SKIRT
- G1 F2400 E0.00000
- G1 F1200 X88.75 Y77.39 E0.02183
- G1 X89.28 Y77.04 E0.03342
- G1 X90.12 Y76.69 E0.05004
- G1 X90.43 Y76.63 E0.05591
- G1 X91.06 Y76.37 E0.06834

A look into slicing parameters

Cura

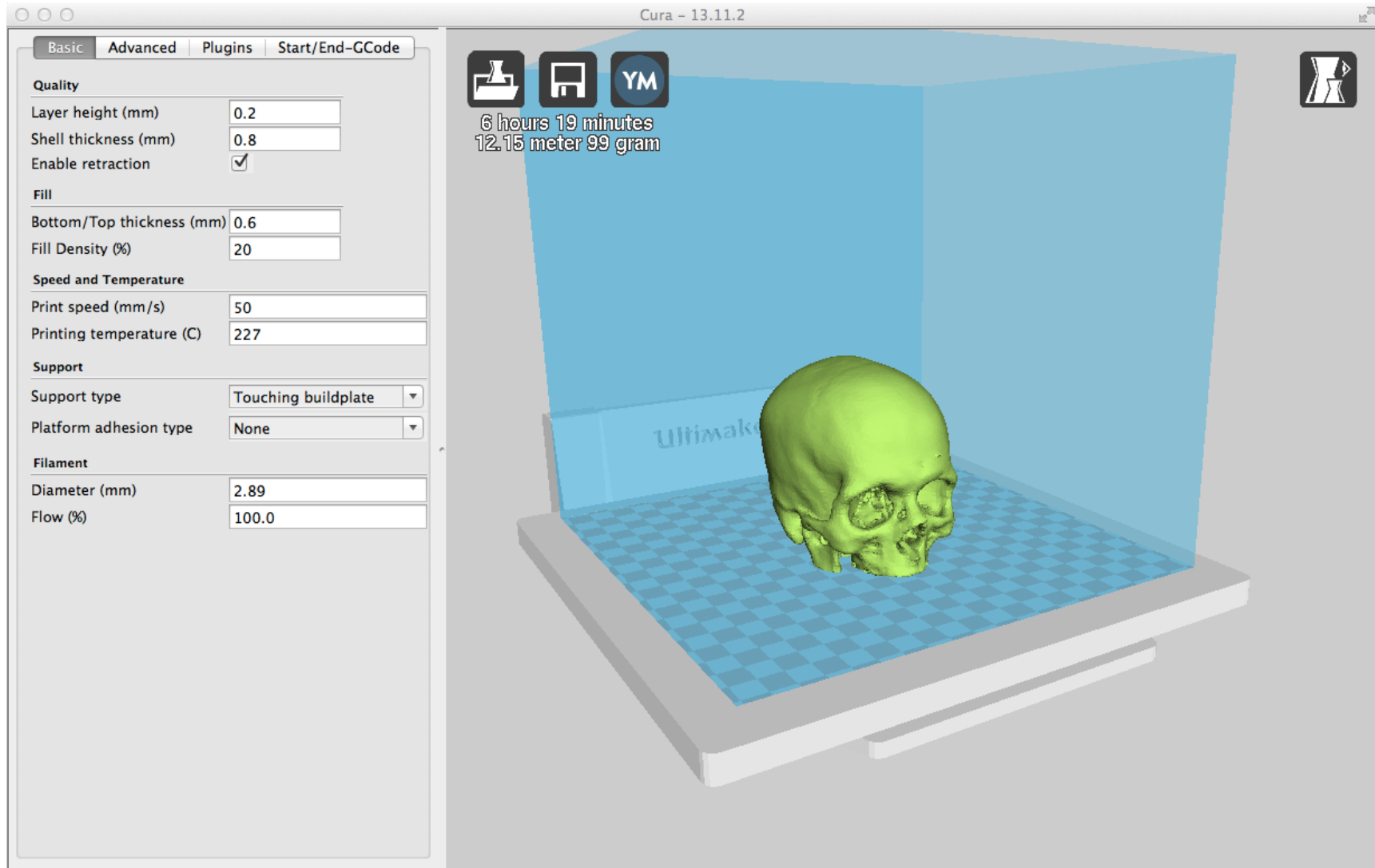

Slic3r

